

DATA SHEET

74HC4066; 74HCT4066 Quad bilateral switches

Product specification
Supersedes data of 1998 Nov 10

2003 Jun 17

Quad bilateral switches

74HC4066; 74HCT4066

FEATURES

- Very low ON-resistance:
 - 50 Ω (typical) at $V_{CC} = 4.5$ V
 - 45 Ω (typical) at $V_{CC} = 6.0$ V
 - 35 Ω (typical) at $V_{CC} = 9.0$ V.
- Complies with JEDEC standard no. 8-1A
- ESD protection:
 - HBM EIA/JESD22-A114-A exceeds 2000 V
 - MM EIA/JESD22-A115-A exceeds 200 V.
- Specified from -40 to $+85$ °C and -40 to $+125$ °C.

GENERAL DESCRIPTION

The 74HC4066 and 74HCT4066 are high-speed Si-gate CMOS devices and are pin compatible with the HEF4066B. They are specified in compliance with JEDEC standard no. 7A.

The 74HC4066 and 74HCT4066 have four independent analog switches. Each switch has two input/output pins (pins nY or nZ) and an active HIGH enable input pin (pin nE). When pin nE = LOW the belonging analog switch is turned off.

The 74HC4066/74HCT4066 is pin compatible with the 74HC4016/74HCT4066 but exhibits a much lower on-resistance. In addition, the on-resistance is relatively constant over the full input signal range.

QUICK REFERENCE DATA

GND = 0 V; $T_{amb} = 25$ °C; $t_r = t_f = 6$ ns.

SYMBOL	PARAMETER	CONDITIONS	TYPICAL		UNIT
			74HC4066	74HCT4066	
t_{PZH}/t_{PZL}	turn-on time nE to V_{os}	$C_L = 15$ pF; $R_L = 1$ k Ω ; $V_{CC} = 5$ V	11	12	ns
t_{PHZ}/t_{PLZ}	turn-off time nE to V_{os}	$C_L = 15$ pF; $R_L = 1$ k Ω ; $V_{CC} = 5$ V	13	16	ns
C_I	input capacitance		3.5	3.5	pF
C_{PD}	power dissipation capacitance per switch	notes 1 and 2	11	12	pF
C_S	maximum switch capacitance		8	8	pF

Notes

1. C_{PD} is used to determine the dynamic power dissipation (P_D in μ W).

$P_D = C_{PD} \times V_{CC}^2 \times f_i \times N + \Sigma[(C_L + C_S) \times V_{CC}^2 \times f_o]$ where:

f_i = input frequency in MHz;

f_o = output frequency in MHz;

C_L = output load capacitance in pF;

C_S = maximum switch capacitance in pF;

V_{CC} = supply voltage in Volts;

N = total load switching outputs;

$\Sigma[(C_L + C_S) \times V_{CC}^2 \times f_o]$ = sum of the outputs.

2. For 74HC4066 the condition is $V_I = \text{GND to } V_{CC}$.
For 74HCT4066 the condition is $V_I = \text{GND to } V_{CC} - 1.5$ V.

Quad bilateral switches

74HC4066; 74HCT4066

FUNCTION TABLE

See note 1.

INPUT nE	SWITCH
L	off
H	on

Note

- 1. H = HIGH voltage level.
- L = LOW voltage level.

ORDERING INFORMATION

TYPE NUMBER	PACKAGE				
	TEMPERATURE RANGE	PINS	PACKAGE	MATERIAL	CODE
74HC4066N	-40 to 125 °C	14	DIP14	plastic	SOT27-1
74HCT4066N	-40 to 125 °C	14	DIP14	plastic	SOT27-1
74HC4066D	-40 to 125 °C	14	SO14	plastic	SOT108-1
74HCT4066D	-40 to 125 °C	14	SO14	plastic	SOT108-1
74HC4066DB	-40 to 125 °C	14	SSOP14	plastic	SOT337-1
74HCT4066DB	-40 to 125 °C	14	SSOP14	plastic	SOT337-1
74HC4066PW	-40 to 125 °C	14	TSSOP14	plastic	SOT402-1
74HCT4066PW	-40 to 125 °C	14	TSSOP14	plastic	SOT402-1
74HC4066BQ	-40 to 125 °C	14	DHVQFN14	plastic	SOT762-1
74HCT4066BQ	-40 to 125 °C	14	DHVQFN14	plastic	SOT762-1

PINNING

PIN	SYMBOL	DESCRIPTION
1	1Y	independent input/output
2	1Z	independent input/output
3	2Z	independent input/output
4	2Y	independent input/output
5	2E	enable input (active HIGH)
6	3E	enable input (active HIGH)
7	GND	ground (0 V)
8	3Y	independent input/output
9	3Z	independent input/output
10	4Z	independent input/output
11	4Y	independent input/output
12	4E	enable input (active HIGH)
13	1E	enable input (active HIGH)
14	V _{CC}	supply voltage

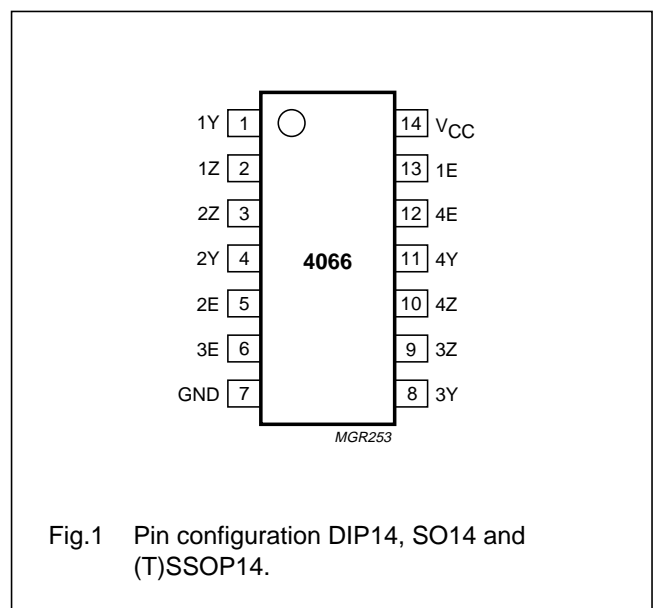
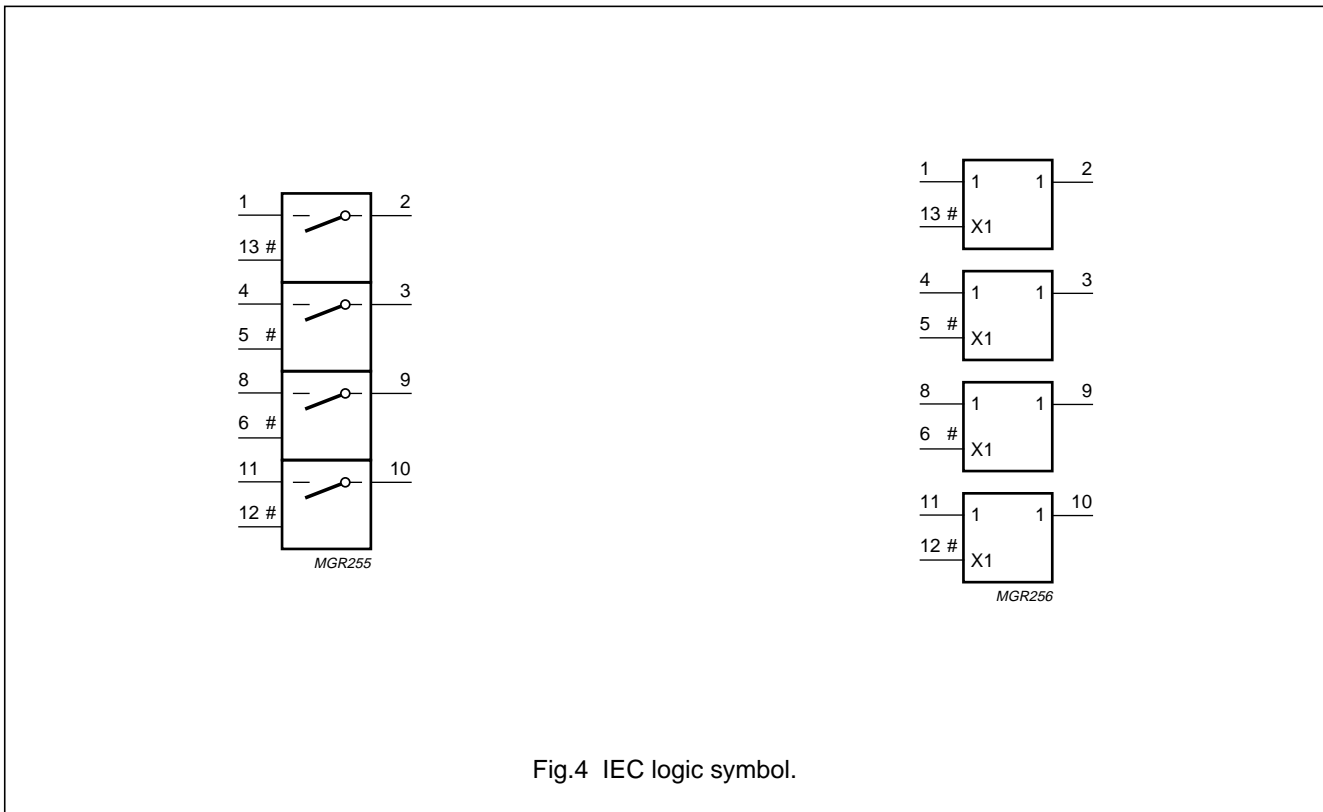
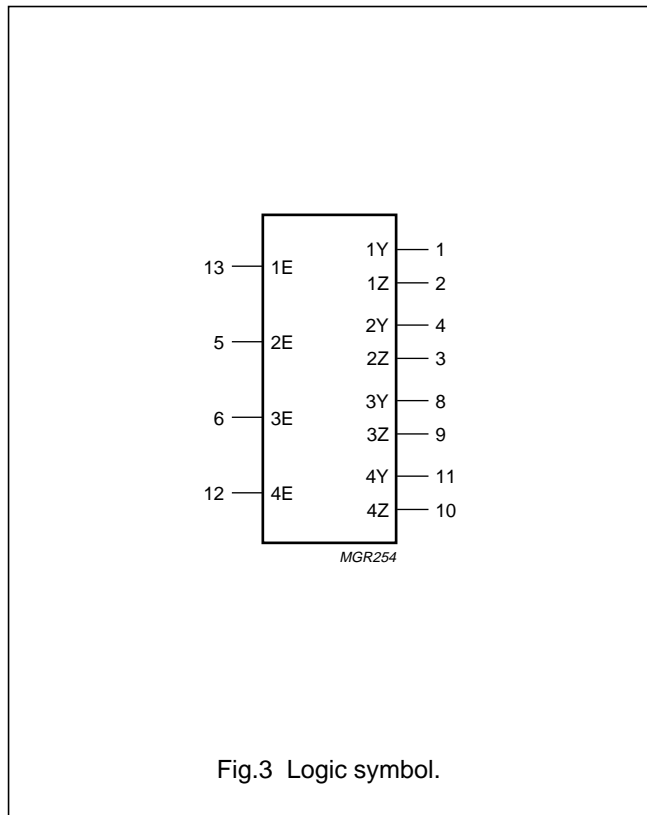
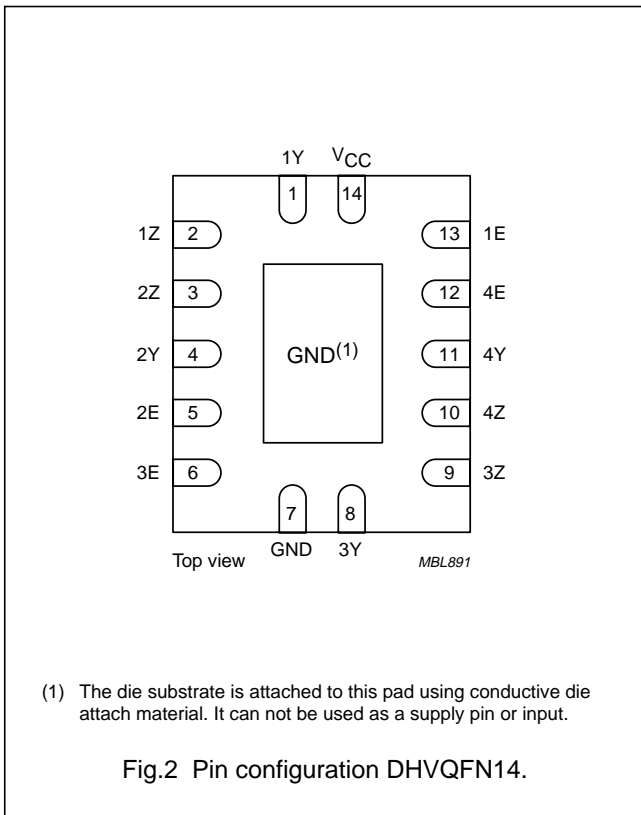

Fig.1 Pin configuration DIP14, SO14 and (T)SSOP14.

Quad bilateral switches

74HC4066; 74HCT4066



Quad bilateral switches

74HC4066; 74HCT4066

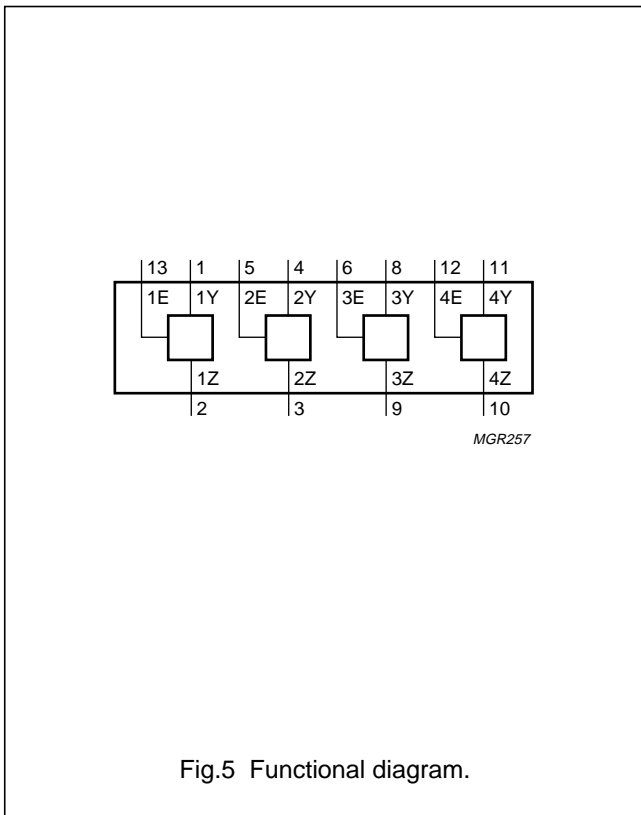

Fig.5 Functional diagram.

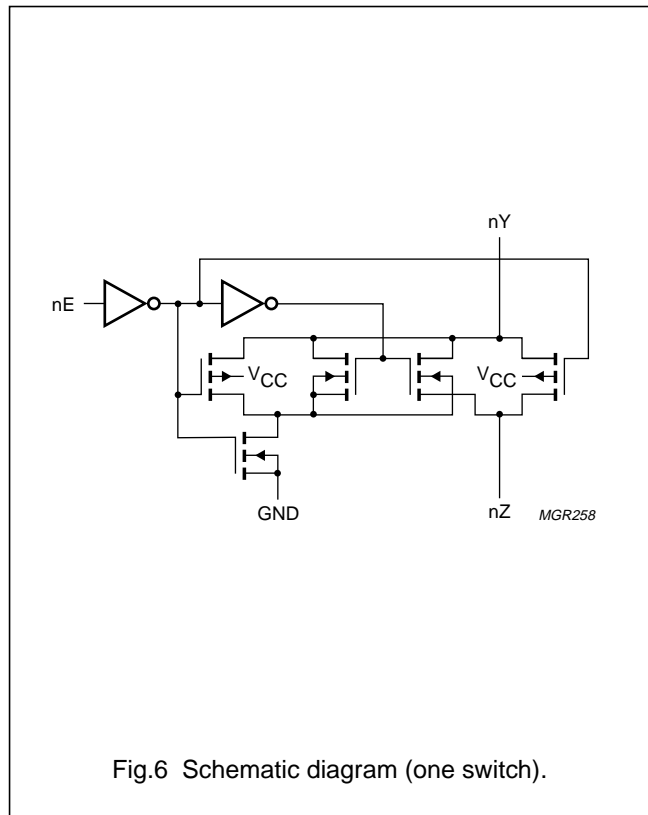

Fig.6 Schematic diagram (one switch).

Quad bilateral switches

74HC4066; 74HCT4066

RECOMMENDED OPERATING CONDITIONS

SYMBOL	PARAMETER	CONDITIONS	74HC4066			74HCT4066			UNIT
			MIN.	TYP.	MAX.	MIN.	TYP.	MAX.	
V_{CC}	supply voltage		2.0	5.0	10.0	4.5	5.0	5.5	V
V_I	input voltage		GND	–	V_{CC}	GND	–	V_{CC}	V
V_S	switch voltage		GND	–	V_{CC}	GND	–	V_{CC}	V
T_{amb}	operating ambient temperature	see DC and AC characteristics per device	–40	+25	+85	–40	+25	+85	°C
			–40	–	+125	–40	–	+125	°C
t_r, t_f	input rise and fall times	$V_{CC} = 2.0$ V	–	6.0	1000	–	6.0	500	ns
		$V_{CC} = 4.5$ V	–	–	500	–	–	–	ns
		$V_{CC} = 6.0$ V	–	–	400	–	–	–	ns
		$V_{CC} = 10.0$ V	–	–	250	–	–	–	ns

LIMITING VALUES

In accordance with the Absolute Maximum Rating System (IEC 60134); voltages are referenced to GND (ground = 0 V).

SYMBOL	PARAMETER	CONDITIONS	MIN.	MAX.	UNIT
V_{CC}	supply voltage		–0.5	+11.0	V
I_{IK}	input diode current	$V_I < -0.5$ V or $V_I > V_{CC} + 0.5$ V	–	± 20	mA
I_{SK}	switch diode current	$V_S < -0.5$ V or $V_S > V_{CC} + 0.5$ V	–	± 20	mA
I_S	switch current	-0.5 V $< V_O < V_{CC} + 0.5$ V; note 1	–	± 25	mA
I_{CC}, I_{GND}	V_{CC} or GND current		–	± 50	mA
T_{stg}	storage temperature		–65	+150	°C
P_{tot}	power dissipation	$T_{amb} = -40$ to $+125$ °C; note 2	–	500	mW
P_S	power dissipation per switch		–	100	mW

Notes

- To avoid drawing V_{CC} current out of pin nZ, when switch current flows in pin nY, the voltage drop across the bidirectional switch must not exceed 0.4 V. If the switch current flows into pin nZ, no V_{CC} current will flow out of pin nY. In this case there is no limit for the voltage drop across the switch, but the voltages at pins nY and nZ may not exceed V_{CC} or GND.
- For DIP14 packages: above 70 °C derate linearly with 12 mW/K.
For SO14 packages: above 70 °C derate linearly with 8 mW/K.
For SSOP14 and TSSOP16 packages: above 60 °C derate linearly with 5.5 mW/K.
For DHVQFN14 packages: above 60 °C derate linearly with 4.5 mW/K.

Quad bilateral switches

74HC4066; 74HCT4066

DC CHARACTERISTICS

Family 74HC4066

Voltages are referenced to GND (ground = 0 V); V_{is} is the input voltage at pins nY or nZ, whichever is assigned as an input; V_{os} is the output voltage at pins nY or nZ, whichever is assigned as an output.

SYMBOL	PARAMETER	TEST CONDITIONS		MIN.	TYP.	MAX.	UNIT
		OTHER	V_{CC} (V)				
$T_{amb} = -40$ to $+85$ °C; note 1							
V_{IH}	HIGH-level input voltage		2.0	1.5	1.2	–	V
			4.5	3.15	2.4	–	V
			6.0	4.2	3.2	–	V
			9.0	6.3	4.7	–	V
V_{IL}	LOW-level input voltage		2.0	–	0.8	0.50	V
			4.5	–	2.1	1.35	V
			6.0	–	2.8	1.80	V
			9.0	–	4.3	2.70	V
I_{LI}	input leakage current	$V_I = V_{CC}$ or GND	6.0	–	–	± 1.0	μA
			10.0	–	–	± 2.0	μA
$I_{S(OFF)}$	analog switch current OFF-state	per channel; $V_I = V_{IH}$ or V_{IL} ; $V_S = V_{CC} - GND$; see Fig.7	10.0	–	–	± 1.0	μA
$I_{S(ON)}$	analog switch current ON-state	$V_I = V_{IH}$ or V_{IL} ; $V_S = V_{CC} - GND$; see Fig.8	10.0	–	–	± 1.0	μA
I_{CC}	quiescent supply current	$V_I = V_{CC}$ or GND; $V_{is} = GND$ or V_{CC} ; $V_{os} = V_{CC}$ or GND	6.0	–	–	20.0	μA
			10.0	–	–	40.0	μA

Quad bilateral switches

74HC4066; 74HCT4066

SYMBOL	PARAMETER	TEST CONDITIONS		MIN.	TYP.	MAX.	UNIT
		OTHER	V _{CC} (V)				
T_{amb} = -40 to +125 °C							
V _{IH}	HIGH-level input voltage		2.0	1.5	–	–	V
			4.5	3.15	–	–	V
			6.0	4.2	–	–	V
			9.0	6.3	–	–	V
V _{IL}	LOW-level input voltage		2.0	–	–	0.50	V
			4.5	–	–	1.35	V
			6.0	–	–	1.80	V
			9.0	–	–	2.70	V
I _{LI}	input leakage current	V _I = V _{CC} or GND	6.0	–	–	±1.0	μA
			10.0	–	–	±2.0	μA
I _{S(OFF)}	analog switch current OFF-state	per channel; V _I = V _{IH} or V _{IL} ; V _S = V _{CC} – GND; see Fig.7	10.0	–	–	±1.0	μA
I _{S(ON)}	analog switch current ON-state	V _I = V _{IH} or V _{IL} ; V _S = V _{CC} – GND; see Fig.8	10.0	–	–	±1.0	μA
I _{CC}	quiescent supply current	V _I = V _{CC} or GND; V _{is} = GND or V _{CC} ; V _{os} = V _{CC} or GND	6.0	–	–	40.0	μA
			10.0	–	–	80.0	μA

Note

1. All typical values are measured at T_{amb} = 25 °C.

Quad bilateral switches

74HC4066; 74HCT4066

Family 74HCT4066

Voltages are referenced to GND (ground = 0 V); V_{is} is the input voltage at pins nY or nZ, whichever is assigned as an input; V_{os} is the output voltage at pins nY or nZ, whichever is assigned as an output.

SYMBOL	PARAMETER	TEST CONDITIONS		MIN.	TYP.	MAX.	UNIT
		OTHER	V_{CC} (V)				
$T_{amb} = -40$ to $+85$ °C; note 1							
V_{IH}	HIGH-level input voltage		4.5 to 5.5	2.0	1.6	–	V
V_{IL}	LOW-level input voltage		4.5 to 5.5	–	1.2	0.8	V
I_{LI}	input leakage current	$V_I = V_{CC}$ or GND	5.5	–	–	± 1.0	μA
$I_{S(OFF)}$	analog switch current OFF-state	per channel; $V_I = V_{IH}$ or V_{IL} ; $V_S = V_{CC} - GND$; see Fig.7	5.5	–	–	± 1.0	μA
$I_{S(ON)}$	analog switch current ON-state	$V_I = V_{IH}$ or V_{IL} ; $V_S = V_{CC} - GND$; see Fig.8	5.5	–	–	± 1.0	μA
I_{CC}	quiescent supply current	$V_I = V_{CC}$ or GND; $V_{is} = GND$ or V_{CC} ; $V_{os} = V_{CC}$ or GND	4.5 to 5.5	–	–	20.0	μA
ΔI_{CC}	additional quiescent supply current per input	$V_I = V_{CC} - 2.1$ V; other inputs at V_{CC} or GND	4.5 to 5.5	–	100	450	μA
$T_{amb} = -40$ to $+125$ °C							
V_{IH}	HIGH-level input voltage		4.5 to 5.5	2.0	–	–	V
V_{IL}	LOW-level input voltage		4.5 to 5.5	–	–	0.8	V
I_{LI}	input leakage current	$V_I = V_{CC}$ or GND	5.5	–	–	± 1.0	μA
$I_{S(OFF)}$	analog switch current OFF-state	per channel; $V_I = V_{IH}$ or V_{IL} ; $V_S = V_{CC} - GND$; see Fig.7	10.0	–	–	± 1.0	μA
$I_{S(ON)}$	analog switch current ON-state	$V_I = V_{IH}$ or V_{IL} ; $V_S = V_{CC} - GND$; see Fig.8	10.0	–	–	± 1.0	μA
I_{CC}	quiescent supply current	$V_I = V_{CC}$ or GND; $V_{is} = GND$ or V_{CC} ; $V_{os} = V_{CC}$ or GND	4.5 to 5.5	–	–	40.0	μA
ΔI_{CC}	additional quiescent supply current per input	$V_I = V_{CC} - 2.1$ V; other inputs at V_{CC} or GND	4.5 to 5.5	–	–	490	μA

Note

1. All typical values are measured at $T_{amb} = 25$ °C.

Quad bilateral switches

74HC4066; 74HCT4066

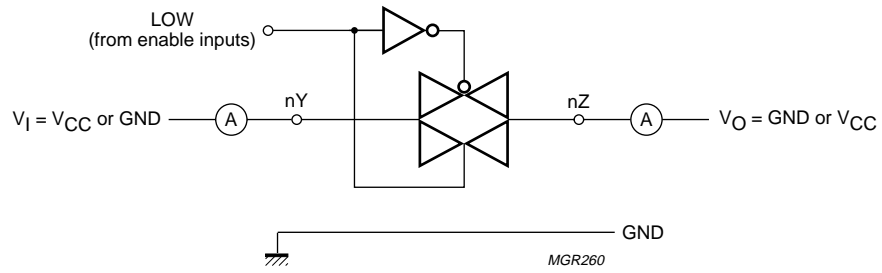

Fig.7 Test circuit for measuring OFF-state current.

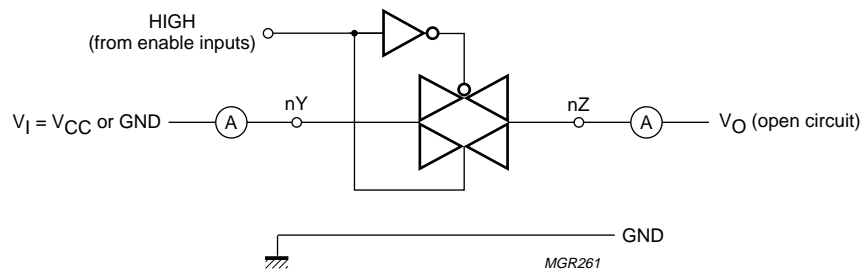

Fig.8 Test circuit for measuring ON-state current.

Quad bilateral switches

74HC4066; 74HCT4066

Resistance R_{ON} for 74HC4066 and 74HCT4066

For 74HC4066: $V_{CC} = 2.0, 4.5, 6.0$ and 9.0 V; for 74HCT4066: $V_{CC} = 4.5$ V; note 1; V_{is} is the input voltage at pins nY or nZ, whichever is assigned as an input; see Fig.9.

SYMBOL	PARAMETER	TEST CONDITIONS			MIN.	TYP.	MAX.	UNIT
		OTHER	I_S (μ A)	V_{CC} (V)				
$T_{amb} = -40$ to $+85$ °C; note 2								
$R_{ON(peak)}$	ON-resistance (peak)	$V_I = V_{IH}$ or V_{IL} ; $V_{is} = V_{CC}$ to GND	100	2.0	–	–	–	Ω
			1000	4.5	–	54	118	Ω
				6.0	–	42	105	Ω
				9.0	–	32	88	Ω
$R_{ON(rail)}$	ON-resistance (rail)	$V_I = V_{IH}$ or V_{IL} ; $V_{is} = GND$	100	2.0	–	80	–	Ω
			1000	4.5	–	35	95	Ω
				6.0	–	27	82	Ω
				9.0	–	20	70	Ω
		$V_I = V_{IH}$ or V_{IL} ; $V_{is} = V_{CC}$	100	2.0	–	100	–	Ω
			1000	4.5	–	42	106	Ω
				6.0	–	35	94	Ω
				9.0	–	27	78	Ω
ΔR_{ON}	maximum variation of ON-resistance between any two channels	$V_I = V_{IH}$ or V_{IL} ; $V_{is} = V_{CC}$ to GND	–	2.0	–	–	–	Ω
			–	4.5	–	5	–	Ω
			–	6.0	–	4	–	Ω
			–	9.0	–	3	–	Ω
$T_{amb} = -40$ to $+125$ °C								
$R_{ON(peak)}$	ON-resistance (peak)	$V_I = V_{IH}$ or V_{IL} ; $V_{is} = V_{CC}$ to GND	100	2.0	–	–	–	Ω
			1000	4.5	–	–	142	Ω
				6.0	–	–	126	Ω
				9.0	–	–	105	Ω
$R_{ON(rail)}$	ON-resistance (rail)	$V_I = V_{IH}$ or V_{IL} ; $V_{is} = GND$	100	2.0	–	–	–	Ω
			1000	4.5	–	–	115	Ω
				6.0	–	–	100	Ω
				9.0	–	–	85	Ω
		$V_I = V_{IH}$ or V_{IL} ; $V_{is} = V_{CC}$	100	2.0	–	–	–	Ω
			1000	4.5	–	–	128	Ω
				6.0	–	–	113	Ω
				9.0	–	–	95	Ω

Notes

- At supply voltages approaching 2 V, the analog ON-resistance switch becomes extremely non-linear. Therefore, it is recommended that these devices are being used to transmit digital signals only, when using these supply voltages.
- All typical values are measured at $T_{amb} = 25$ °C.

Quad bilateral switches

74HC4066; 74HCT4066

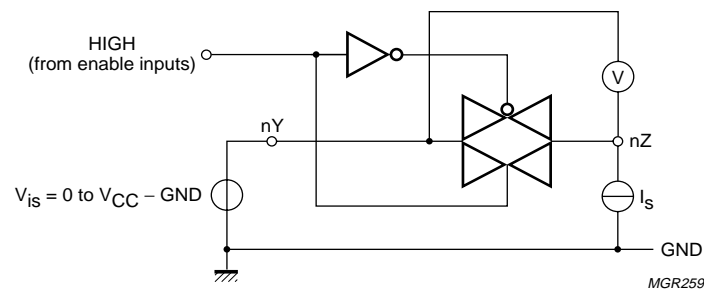
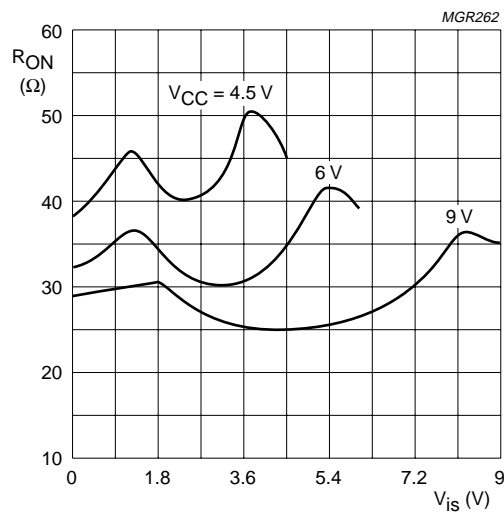

Fig.9 Test circuit for measuring ON-resistance (R_{ON}).



$V_{is} = 0$ to V_{CC} .

Fig.10 Typical ON-resistance (R_{ON}) as a function of input voltage (V_{is}).

Quad bilateral switches

74HC4066; 74HCT4066

AC CHARACTERISTICS

Type 74HC4066

GND = 0 V; $t_r = t_f = 6$ ns; $C_L = 50$ pF; V_{is} is the input voltage at pins nY or nZ, whichever is assigned as an input; V_{os} is the output voltage at pins nY or nZ, whichever is assigned as an output.

SYMBOL	PARAMETER	TEST CONDITIONS		MIN.	TYP.	MAX.	UNIT
		OTHER	V_{CC} (V)				
$T_{amb} = -40$ to $+85$ °C; note 1							
t_{PHL}/t_{PLH}	propagation delay V_{is} to V_{os}	$R_L = \infty$; see Fig.19	2.0	–	8	75	ns
			4.5	–	3	15	ns
			6.0	–	2	13	ns
			9.0	–	2	10	ns
t_{PZH}/t_{PZL}	turn-on time nE to V_{os}	$R_L = 1$ k Ω ; see Figs 20 and 21	2.0	–	36	125	ns
			4.5	–	13	25	ns
			6.0	–	10	21	ns
			9.0	–	8	16	ns
t_{PHZ}/t_{PLZ}	turn-off time nE to V_{os}	$R_L = 1$ k Ω ; see Figs 20 and 21	2.0	–	44	190	ns
			4.5	–	16	38	ns
			6.0	–	13	33	ns
			9.0	–	16	26	ns
$T_{amb} = -40$ to $+125$ °C							
t_{PHL}/t_{PLH}	propagation delay V_{is} to V_{os}	$R_L = \infty$; see Fig.19	2.0	–	–	90	ns
			4.5	–	–	18	ns
			6.0	–	–	15	ns
			9.0	–	–	12	ns
t_{PZH}/t_{PZL}	turn-on time nE to V_{os}	$R_L = 1$ k Ω ; see Figs 20 and 21	2.0	–	–	150	ns
			4.5	–	–	30	ns
			6.0	–	–	26	ns
			9.0	–	–	20	ns
t_{PHZ}/t_{PLZ}	turn-off time nE to V_{os}	$R_L = 1$ k Ω ; see Figs 20 and 21	2.0	–	–	225	ns
			4.5	–	–	45	ns
			6.0	–	–	38	ns
			9.0	–	–	30	ns

Note

1. All typical values are measured at $T_{amb} = 25$ °C.

Quad bilateral switches

74HC4066; 74HCT4066

Type 74HCT4066

GND = 0 V; $t_r = t_f = 6$ ns; $C_L = 50$ pF; V_{is} is the input voltage at pins nY or nZ, whichever is assigned as an input; V_{os} is the output voltage at pins nY or nZ, whichever is assigned as an output.

SYMBOL	PARAMETER	TEST CONDITIONS		MIN.	TYP.	MAX.	UNIT
		OTHER	V_{CC} (V)				
$T_{amb} = -40$ to $+85$ °C; note 1							
t_{PHL}/t_{PLH}	propagation delay V_{is} to V_{os}	$R_L = \infty$; see Fig.19	4.5	–	3	15	ns
t_{PZH}/t_{PZL}	turn-on time nE to V_{os}	$R_L = 1$ k Ω ; see Figs 20 and 21	4.5	–	12	30	ns
t_{PHZ}/t_{PLZ}	turn-off time nE to V_{os}	$R_L = 1$ k Ω ; see Figs 20 and 21	4.5	–	20	44	ns
$T_{amb} = -40$ to $+125$ °C							
t_{PHL}/t_{PLH}	propagation delay V_{is} to V_{os}	$R_L = \infty$; see Fig.19	4.5	–	–	18	ns
t_{PZH}/t_{PZL}	turn-on time nE to V_{os}	$R_L = 1$ k Ω ; see Figs 20 and 21	4.5	–	–	36	ns
t_{PHZ}/t_{PLZ}	turn-off time nE to V_{os}	$R_L = 1$ k Ω ; see Figs 20 and 21	4.5	–	–	53	ns

Note

1. All typical values are measured at $T_{amb} = 25$ °C.

74HC4066 and 74HCT4066

At recommended conditions and typical values; GND = 0 V; $t_r = t_f = 6$ ns; V_{is} is the input voltage at pins nY or nZ, whichever is assigned as an input; V_{os} is the output voltage at pins nY or nZ, whichever is assigned as an output.

SYMBOL	PARAMETER	CONDITIONS			TYP.	UNIT
		OTHER	$V_{is(p-p)}$ (V)	V_{CC} (V)		
d_{sin}	sine wave distortion	$f = 1$ kHz; $R_L = 10$ k Ω ; $C_L = 50$ pF; see Fig.17	4.0	4.5	0.04	%
			8.0	9.0	0.02	%
		$f = 10$ kHz; $R_L = 10$ k Ω ; $C_L = 50$ pF; see Fig.17	4.0	4.5	0.12	%
			8.0	9.0	0.06	%
$\alpha_{OFF(feethr)}$	switch OFF signal feed-through	$R_L = 600$ Ω ; $C_L = 50$ pF; $f = 1$ MHz; see Figs 11 and 18	note 1	4.5	–50	dB
				9.0	–50	dB
$\alpha_{ct(s)}$	crosstalk between any two switches	$R_L = 600$ Ω ; $C_L = 50$ pF; $f = 1$ MHz; see Fig.13	note 1	4.5	–60	dB
				9.0	–60	dB
$V_{ct(p-p)}$	crosstalk voltage between any input to any switch (peak-to-peak value)	$R_L = 600$ Ω ; $C_L = 50$ pF; $f = 1$ MHz; see Fig.15 (nE, square wave between V_{CC} and GND, $t_r = t_f = 6$ ns)	–	4.5	110	mV
				9.0	220	mV
f_{max}	minimum frequency response (–3 dB)	$R_L = 50$ Ω ; $C_L = 10$ pF; see Figs 12 and 16	note 2	4.5	180	MHz
				9.0	200	MHz
C_S	maximum switch capacitance		–	–	8	pF

Notes

- Adjust input voltage V_{is} is 0 dBm level (0 dBm = 1 mW into 600 Ω).
- Adjust input voltage V_{is} is 0 dBm level at V_{os} for 1 MHz (0 dBm = 1 mW into 50 Ω).

Quad bilateral switches

74HC4066; 74HCT4066

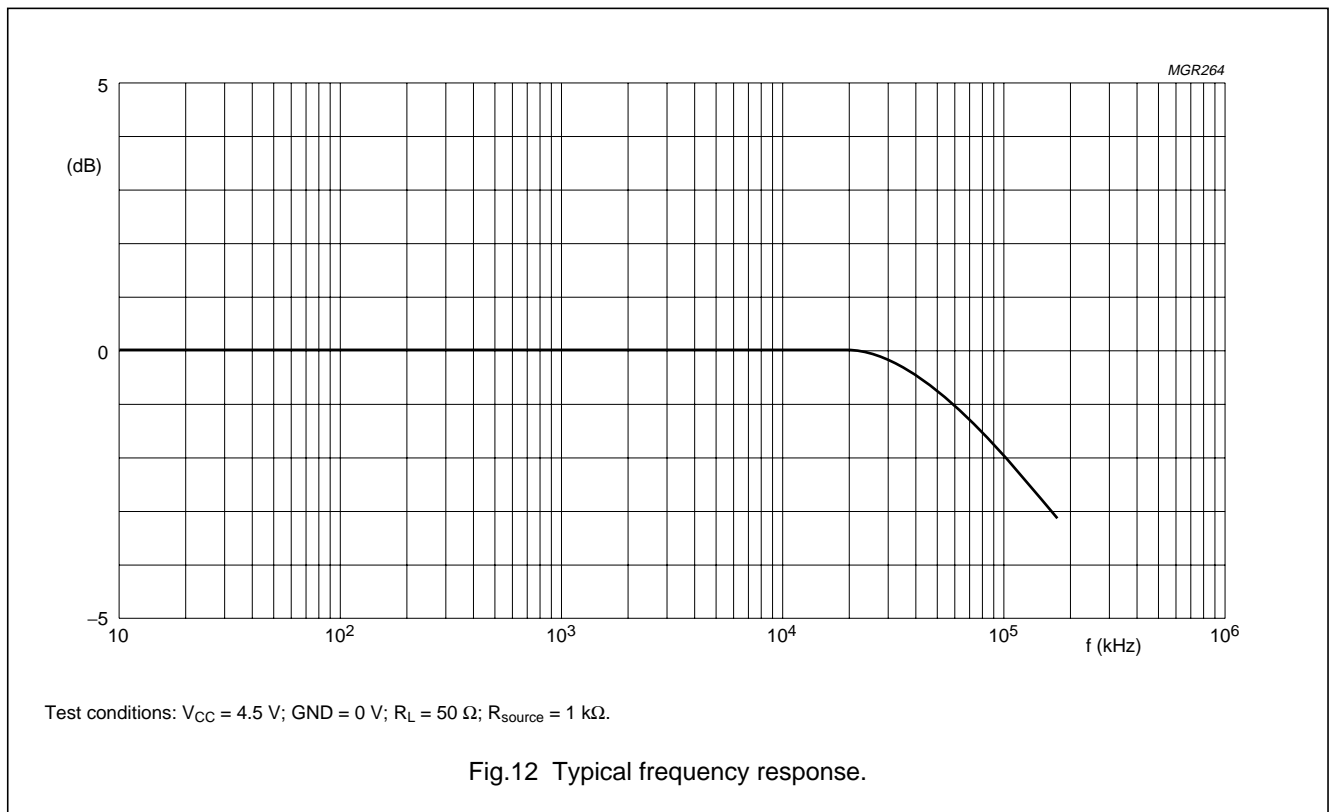
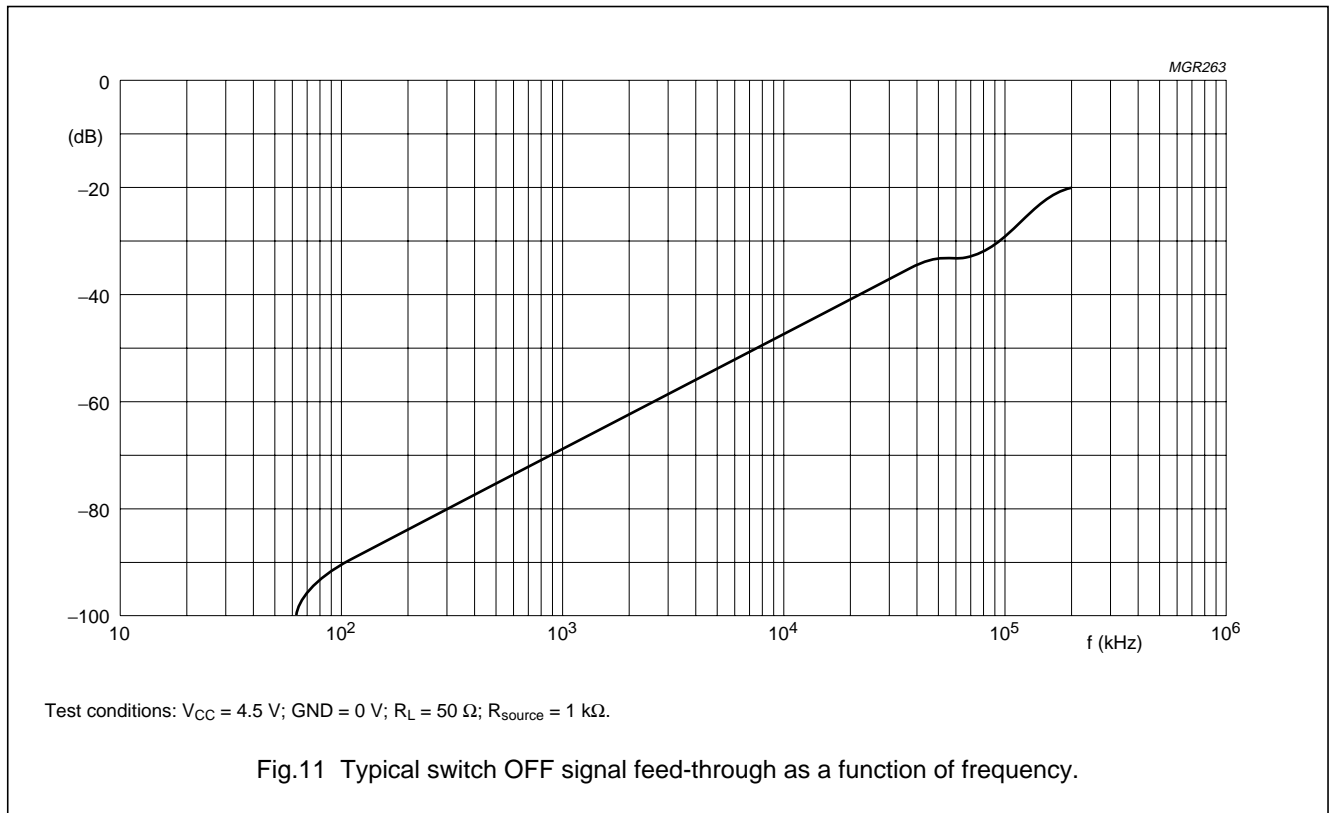

Quad bilateral switches

74HC4066; 74HCT4066

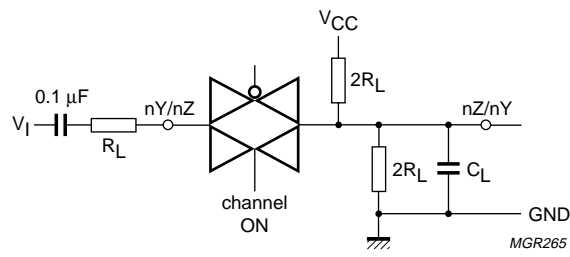

Fig.13 Test circuit for measuring crosstalk between any two switches; channels ON condition.

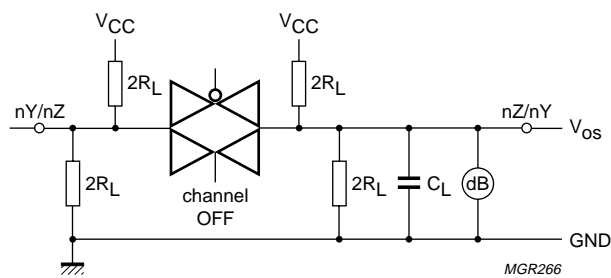

Fig.14 Test circuit for measuring crosstalk between any two switches; channels OFF condition.

Quad bilateral switches

74HC4066; 74HCT4066

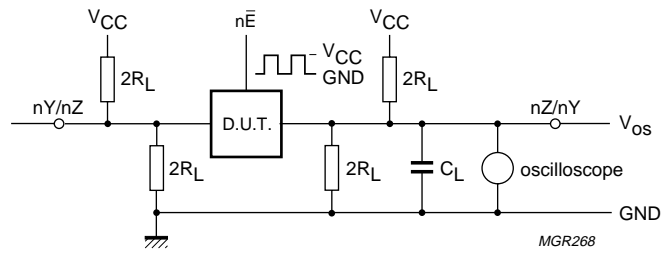
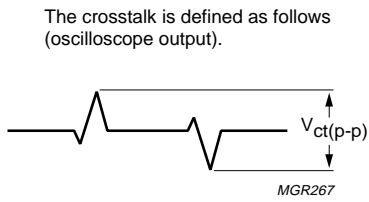
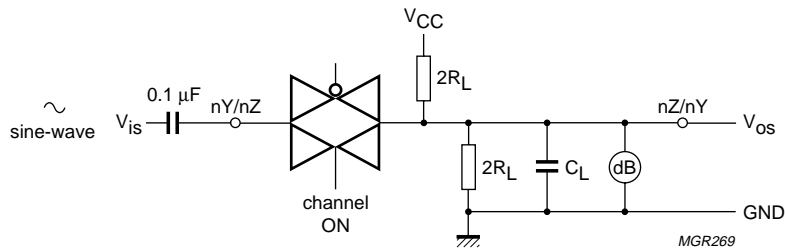

Fig.15 Test circuit for measuring crosstalk between control and any switch.



Adjust input voltage to obtain 0 dB at V_{0s} when $f_i = 1$ MHz. After set-up, the frequency of f_i is increased to obtain a reading of -3 dB at V_{0s} .

Fig.16 Test circuit for measuring minimum frequency response.

Quad bilateral switches

74HC4066; 74HCT4066

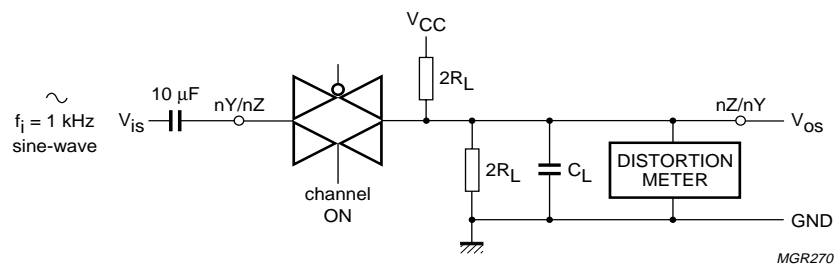

Fig.17 Test circuit for measuring sine wave distortion.

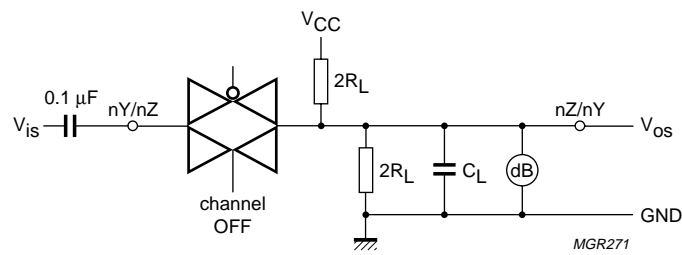

Fig.18 Test circuit for measuring switch OFF signal feed-through.

Quad bilateral switches

74HC4066; 74HCT4066

AC WAVEFORMS

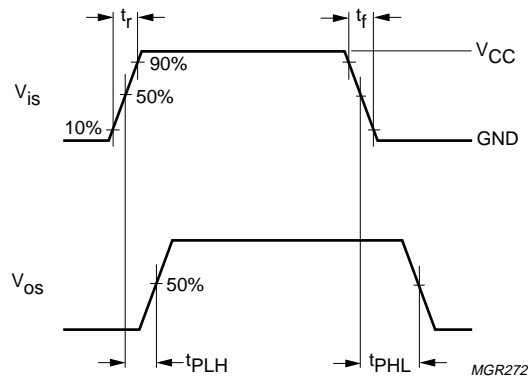
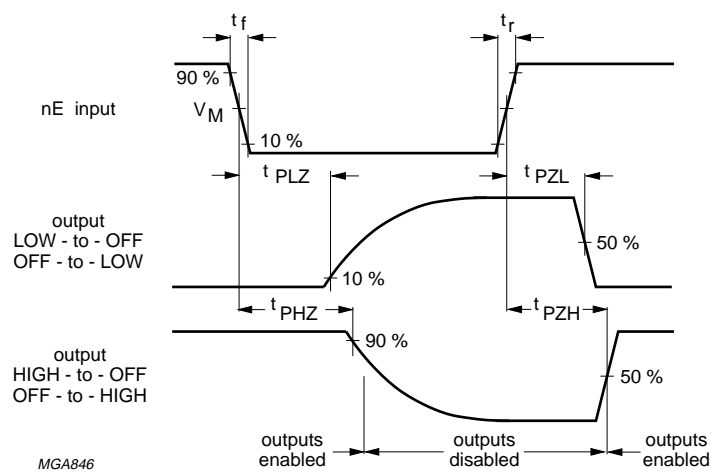

Fig.19 Waveforms showing the input (V_{is}) to output (V_{os}) propagation delays.



74HC4066: $V_M = 50\%$; $V_I = GND$ to V_{CC} .
 74HCT4066: $V_M = 1.3 V$; $V_I = GND$ to $3 V$.

Fig.20 Waveforms showing the turn-on and turn-off times.

Quad bilateral switches

74HC4066; 74HCT4066

TEST CIRCUIT AND WAVEFORMS

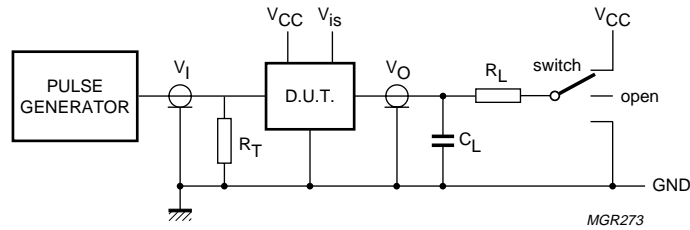

TEST	SWITCH	V _{is}
t _{PZH}	GND	V _{CC}
t _{PZL}	V _{CC}	GND
t _{PHZ}	GND	V _{CC}
t _{PLZ}	V _{CC}	GND
other	open	pulse

Definitions for test circuit:

R_L = Load resistance.

C_L = Load capacitance including jig and probe capacitance.

R_T = Termination resistance should be equal to the output impedance Z_O of the pulse generator.

t_r = 6 ns; when measuring f_{max}, there is no constraint to t_r and t_f with 50% duty factor.

Fig.21 Test circuit for measuring AC performance.

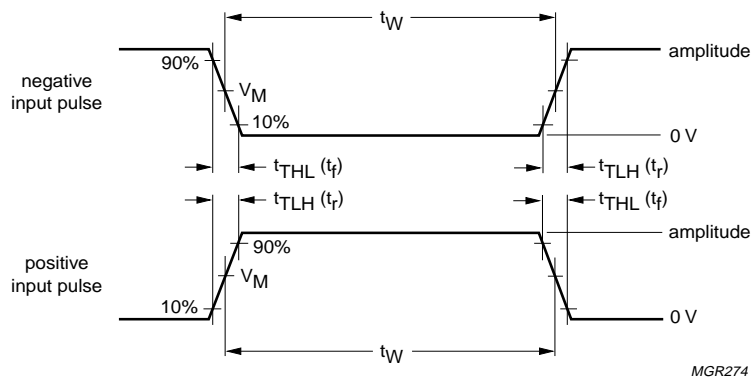

FAMILY	AMPLITUDE	V _M	t _r and t _f	
			f _{max} ; PULSE WIDTH	OTHER
74HC4066	V _{CC}	50%	<2 ns	6 ns
74HCT4066	3.0 V	1.3 V	<2 ns	6 ns

Fig.22 Input pulse definitions.

Quad bilateral switches

74HC4066; 74HCT4066

PACKAGE OUTLINES

DIP14: plastic dual in-line package; 14 leads (300 mil)

SOT27-1

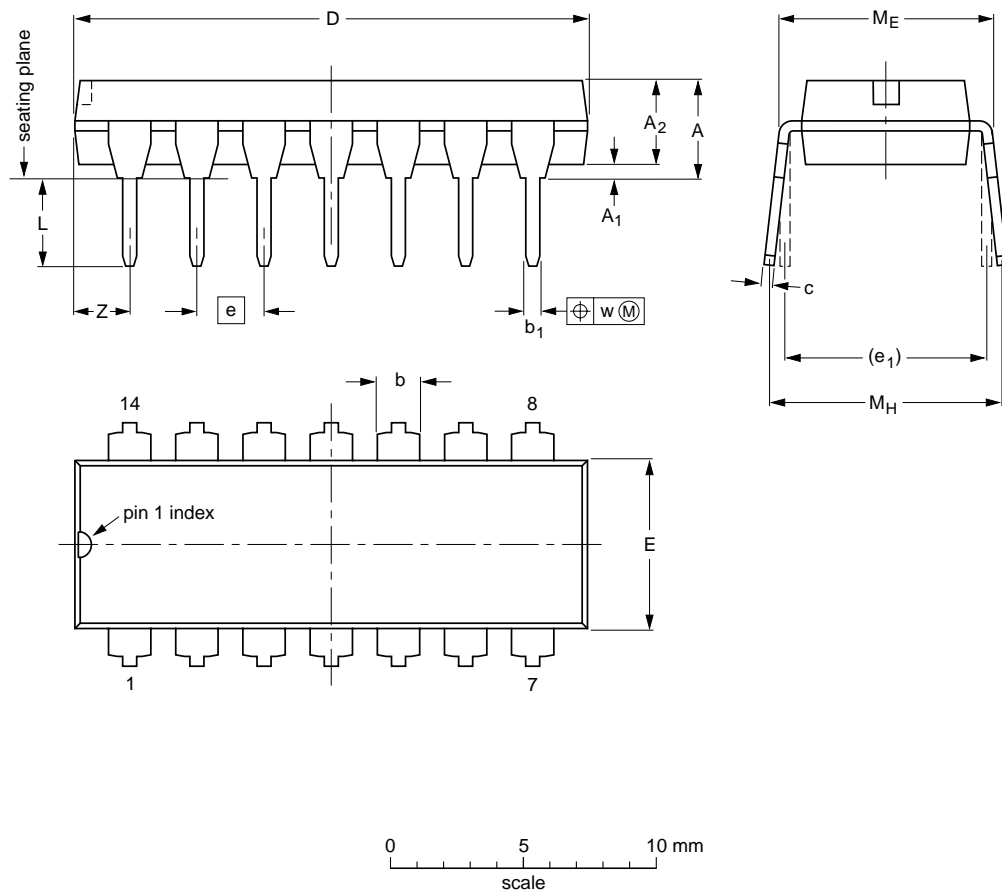

DIMENSIONS (inch dimensions are derived from the original mm dimensions)

UNIT	A max.	A ₁ min.	A ₂ max.	b	b ₁	c	D ⁽¹⁾	E ⁽¹⁾	e	e ₁	L	M _E	M _H	w	z ⁽¹⁾ max.
mm	4.2	0.51	3.2	1.73 1.13	0.53 0.38	0.36 0.23	19.50 18.55	6.48 6.20	2.54	7.62	3.60 3.05	8.25 7.80	10.0 8.3	0.254	2.2
inches	0.17	0.02	0.13	0.068 0.044	0.021 0.015	0.014 0.009	0.77 0.73	0.26 0.24	0.1	0.3	0.14 0.12	0.32 0.31	0.39 0.33	0.01	0.087

Note

1. Plastic or metal protrusions of 0.25 mm (0.01 inch) maximum per side are not included.

OUTLINE VERSION	REFERENCES			EUROPEAN PROJECTION	ISSUE DATE
	IEC	JEDEC	JEITA		
SOT27-1	050G04	MO-001	SC-501-14		99-12-27 03-02-13

Quad bilateral switches

74HC4066; 74HCT4066

SO14: plastic small outline package; 14 leads; body width 3.9 mm

SOT108-1

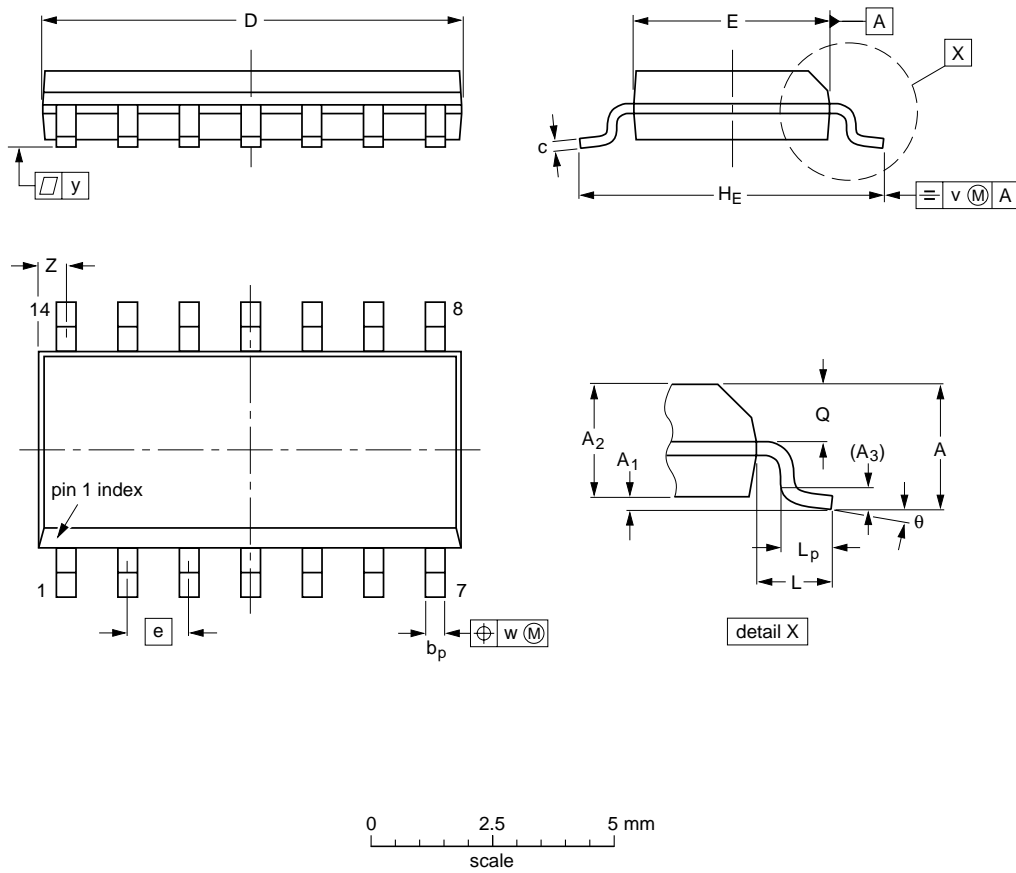

DIMENSIONS (inch dimensions are derived from the original mm dimensions)

UNIT	A max.	A ₁	A ₂	A ₃	b _p	c	D ⁽¹⁾	E ⁽¹⁾	e	H _E	L	L _p	Q	v	w	y	Z ⁽¹⁾	θ
mm	1.75	0.25 0.10	1.45 1.25	0.25	0.49 0.36	0.25 0.19	8.75 8.55	4.0 3.8	1.27	6.2 5.8	1.05	1.0 0.4	0.7 0.6	0.25	0.25	0.1	0.7 0.3	8° 0°
inches	0.069	0.010 0.004	0.057 0.049	0.01	0.019 0.014	0.0100 0.0075	0.35 0.34	0.16 0.15	0.05	0.244 0.228	0.041	0.039 0.016	0.028 0.024	0.01	0.01	0.004	0.028 0.012	

Note

1. Plastic or metal protrusions of 0.15 mm (0.006 inch) maximum per side are not included.

OUTLINE VERSION	REFERENCES				EUROPEAN PROJECTION	ISSUE DATE
	IEC	JEDEC	JEITA			
SOT108-1	076E06	MS-012				99-12-27 03-02-19

Quad bilateral switches

74HC4066; 74HCT4066

SSOP14: plastic shrink small outline package; 14 leads; body width 5.3 mm

SOT337-1

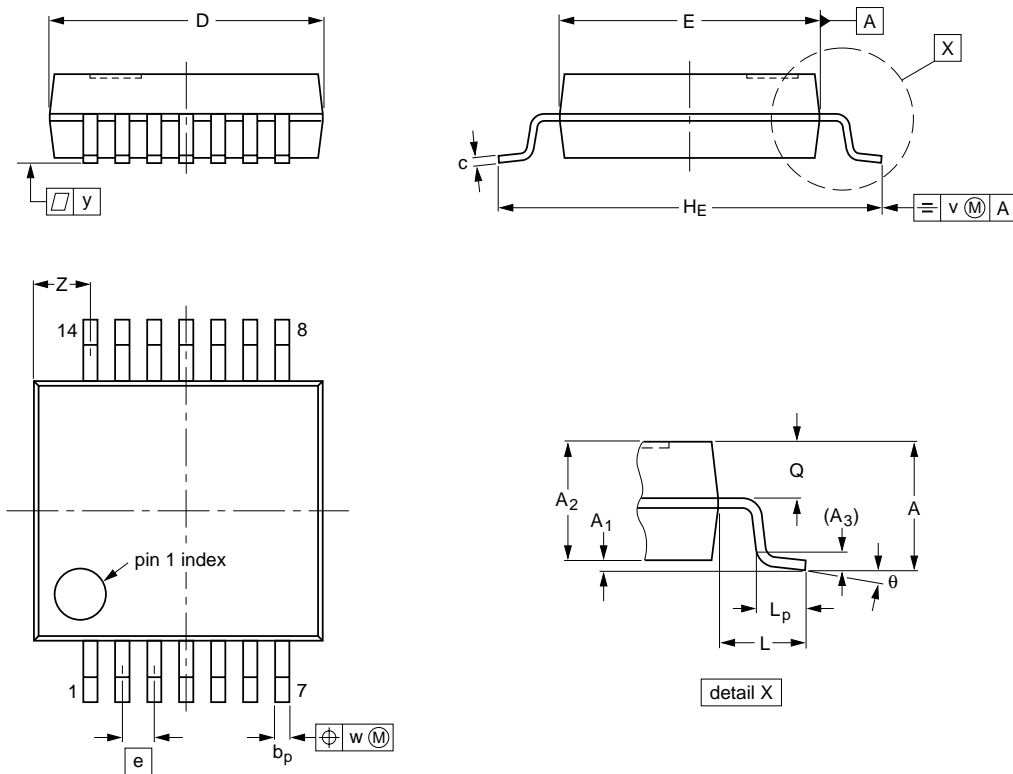

DIMENSIONS (mm are the original dimensions)

UNIT	A max.	A ₁	A ₂	A ₃	b _p	c	D ⁽¹⁾	E ⁽¹⁾	e	H _E	L	L _p	Q	v	w	y	z ⁽¹⁾	θ
mm	2	0.21 0.05	1.80 1.65	0.25	0.38 0.25	0.20 0.09	6.4 6.0	5.4 5.2	0.65	7.9 7.6	1.25	1.03 0.63	0.9 0.7	0.2	0.13	0.1	1.4 0.9	8° 0°

Note

1. Plastic or metal protrusions of 0.25 mm maximum per side are not included.

OUTLINE VERSION	REFERENCES				EUROPEAN PROJECTION	ISSUE DATE
	IEC	JEDEC	JEITA			
SOT337-1		MO-150				99-12-27 03-02-19

Quad bilateral switches

74HC4066; 74HCT4066

TSSOP14: plastic thin shrink small outline package; 14 leads; body width 4.4 mm

SOT402-1

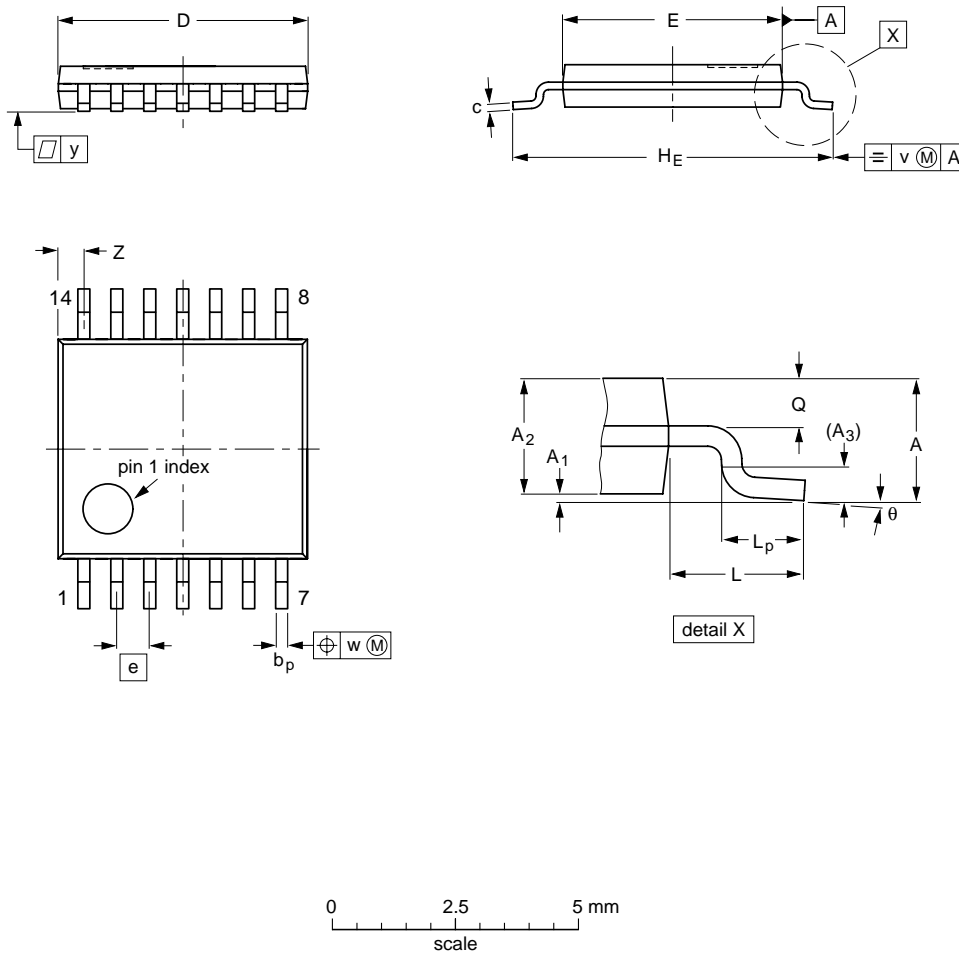

DIMENSIONS (mm are the original dimensions)

UNIT	A max.	A ₁	A ₂	A ₃	b _p	c	D ⁽¹⁾	E ⁽²⁾	e	H _E	L	L _p	Q	v	w	y	z ⁽¹⁾	θ
mm	1.1	0.15 0.05	0.95 0.80	0.25	0.30 0.19	0.2 0.1	5.1 4.9	4.5 4.3	0.65	6.6 6.2	1	0.75 0.50	0.4 0.3	0.2	0.13	0.1	0.72 0.38	8° 0°

Notes

1. Plastic or metal protrusions of 0.15 mm maximum per side are not included.
2. Plastic interlead protrusions of 0.25 mm maximum per side are not included.

OUTLINE VERSION	REFERENCES				EUROPEAN PROJECTION	ISSUE DATE
	IEC	JEDEC	JEITA			
SOT402-1		MO-153				99-12-27 03-02-18

Quad bilateral switches

74HC4066; 74HCT4066

DHVQFN14: plastic dual in-line compatible thermal enhanced very thin quad flat package; no leads; 14 terminals; body 2.5 x 3 x 0.85 mm **SOT762-1**

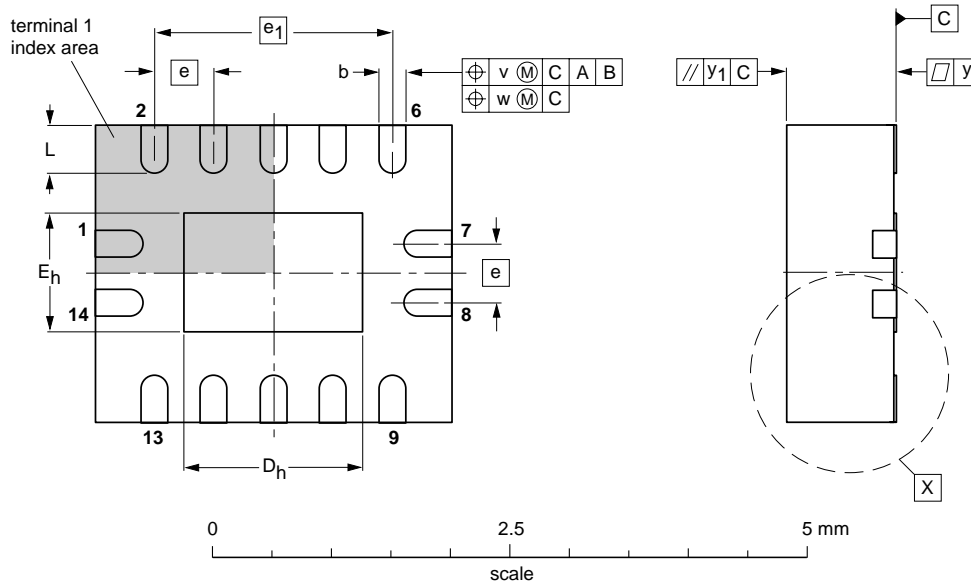
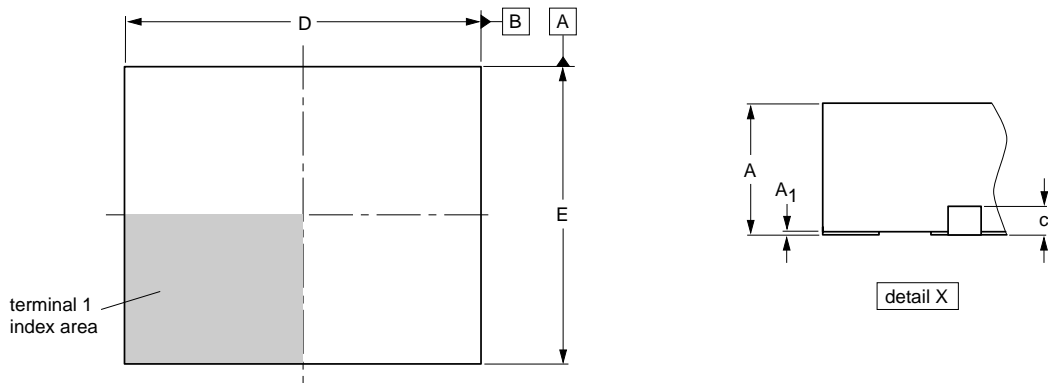

DIMENSIONS (mm are the original dimensions)

UNIT	A ⁽¹⁾ max.	A ₁	b	c	D ⁽¹⁾	D _h	E ⁽¹⁾	E _h	e	e ₁	L	v	w	y	y ₁
mm	1	0.05 0.00	0.30 0.18	0.2	3.1 2.9	1.65 1.35	2.6 2.4	1.15 0.85	0.5	2	0.5 0.3	0.1	0.05	0.05	0.1

Note

1. Plastic or metal protrusions of 0.075 mm maximum per side are not included.

OUTLINE VERSION	REFERENCES				EUROPEAN PROJECTION	ISSUE DATE
	IEC	JEDEC	JEITA			
SOT762-1	---	MO-241	---			02-10-17 03-01-27

Quad bilateral switches

74HC4066; 74HCT4066

SOLDERING

Introduction

This text gives a very brief insight to a complex technology. A more in-depth account of soldering ICs can be found in our *"Data Handbook IC26; Integrated Circuit Packages"* (document order number 9398 652 90011).

There is no soldering method that is ideal for all IC packages. Wave soldering is often preferred when through-hole and surface mount components are mixed on one printed-circuit board. Wave soldering can still be used for certain surface mount ICs, but it is not suitable for fine pitch SMDs. In these situations reflow soldering is recommended. Driven by legislation and environmental forces the worldwide use of lead-free solder pastes is increasing.

Through-hole mount packages

SOLDERING BY DIPPING OR BY SOLDER WAVE

Typical dwell time of the leads in the wave ranges from 3 to 4 seconds at 250 °C or 265 °C, depending on solder material applied, SnPb or Pb-free respectively.

The total contact time of successive solder waves must not exceed 5 seconds.

The device may be mounted up to the seating plane, but the temperature of the plastic body must not exceed the specified maximum storage temperature ($T_{stg(max)}$). If the printed-circuit board has been pre-heated, forced cooling may be necessary immediately after soldering to keep the temperature within the permissible limit.

MANUAL SOLDERING

Apply the soldering iron (24 V or less) to the lead(s) of the package, either below the seating plane or not more than 2 mm above it. If the temperature of the soldering iron bit is less than 300 °C it may remain in contact for up to 10 seconds. If the bit temperature is between 300 and 400 °C, contact may be up to 5 seconds.

Surface mount packages

REFLOW SOLDERING

Reflow soldering requires solder paste (a suspension of fine solder particles, flux and binding agent) to be applied to the printed-circuit board by screen printing, stencilling or pressure-syringe dispensing before package placement.

Several methods exist for reflowing; for example, convection or convection/infrared heating in a conveyor

type oven. Throughput times (preheating, soldering and cooling) vary between 100 and 200 seconds depending on heating method.

Typical reflow peak temperatures range from 215 to 270 °C depending on solder paste material. The top-surface temperature of the packages should preferably be kept:

- below 220 °C (SnPb process) or below 245 °C (Pb-free process)
 - for all the BGA packages
 - for packages with a thickness ≥ 2.5 mm
 - for packages with a thickness < 2.5 mm and a volume ≥ 350 mm³ so called thick/large packages.
- below 235 °C (SnPb process) or below 260 °C (Pb-free process) for packages with a thickness < 2.5 mm and a volume < 350 mm³ so called small/thin packages.

Moisture sensitivity precautions, as indicated on packing, must be respected at all times.

WAVE SOLDERING

Conventional single wave soldering is not recommended for surface mount devices (SMDs) or printed-circuit boards with a high component density, as solder bridging and non-wetting can present major problems.

To overcome these problems the double-wave soldering method was specifically developed.

If wave soldering is used the following conditions must be observed for optimal results:

- Use a double-wave soldering method comprising a turbulent wave with high upward pressure followed by a smooth laminar wave.
- For packages with leads on two sides and a pitch (e):
 - larger than or equal to 1.27 mm, the footprint longitudinal axis is **preferred** to be parallel to the transport direction of the printed-circuit board;
 - smaller than 1.27 mm, the footprint longitudinal axis **must** be parallel to the transport direction of the printed-circuit board.

The footprint must incorporate solder thieves at the downstream end.

- For packages with leads on four sides, the footprint must be placed at a 45° angle to the transport direction of the printed-circuit board. The footprint must incorporate solder thieves downstream and at the side corners.

Quad bilateral switches

74HC4066; 74HCT4066

During placement and before soldering, the package must be fixed with a droplet of adhesive. The adhesive can be applied by screen printing, pin transfer or syringe dispensing. The package can be soldered after the adhesive is cured.

Typical dwell time of the leads in the wave ranges from 3 to 4 seconds at 250 °C or 265 °C, depending on solder material applied, SnPb or Pb-free respectively.

A mildly-activated flux will eliminate the need for removal of corrosive residues in most applications.

MANUAL SOLDERING

Fix the component by first soldering two diagonally-opposite end leads. Use a low voltage (24 V or less) soldering iron applied to the flat part of the lead. Contact time must be limited to 10 seconds at up to 300 °C. When using a dedicated tool, all other leads can be soldered in one operation within 2 to 5 seconds between 270 and 320 °C.

Suitability of IC packages for wave, reflow and dipping soldering methods

MOUNTING	PACKAGE ⁽¹⁾	SOLDERING METHOD		
		WAVE	REFLOW ⁽²⁾	DIPPING
Through-hole mount	DBS, DIP, HDIP, SDIP, SIL	suitable ⁽³⁾	–	suitable
Surface mount	BGA, LBGA, LFBGA, SQFP, TFBGA, VFBGA	not suitable	suitable	–
	DHVQFN, HBCC, HBGA, HLQFP, HSQFP, HSOP, HTQFP, HTSSOP, HVQFN, HVSON, SMS	not suitable ⁽⁴⁾	suitable	–
	PLCC ⁽⁵⁾ , SO, SOJ	suitable	suitable	–
	LQFP, QFP, TQFP	not recommended ⁽⁵⁾⁽⁶⁾	suitable	–
	SSOP, TSSOP, VSO, VSSOP	not recommended ⁽⁷⁾	suitable	–

Notes

- For more detailed information on the BGA packages refer to the “(LF)BGA Application Note” (AN01026); order a copy from your Philips Semiconductors sales office.
- All surface mount (SMD) packages are moisture sensitive. Depending upon the moisture content, the maximum temperature (with respect to time) and body size of the package, there is a risk that internal or external package cracks may occur due to vaporization of the moisture in them (the so called popcorn effect). For details, refer to the Drypack information in the “Data Handbook IC26; Integrated Circuit Packages; Section: Packing Methods”.
- For SDIP packages, the longitudinal axis must be parallel to the transport direction of the printed-circuit board.
- These packages are not suitable for wave soldering. On versions with the heatsink on the bottom side, the solder cannot penetrate between the printed-circuit board and the heatsink. On versions with the heatsink on the top side, the solder might be deposited on the heatsink surface.
- If wave soldering is considered, then the package must be placed at a 45° angle to the solder wave direction. The package footprint must incorporate solder thieves downstream and at the side corners.
- Wave soldering is suitable for LQFP, QFP and TQFP packages with a pitch (e) larger than 0.8 mm; it is definitely not suitable for packages with a pitch (e) equal to or smaller than 0.65 mm.
- Wave soldering is suitable for SSOP, TSSOP, VSO and VSSOP packages with a pitch (e) equal to or larger than 0.65 mm; it is definitely not suitable for packages with a pitch (e) equal to or smaller than 0.5 mm.

Quad bilateral switches

74HC4066; 74HCT4066

DATA SHEET STATUS

LEVEL	DATA SHEET STATUS ⁽¹⁾	PRODUCT STATUS ⁽²⁾⁽³⁾	DEFINITION
I	Objective data	Development	This data sheet contains data from the objective specification for product development. Philips Semiconductors reserves the right to change the specification in any manner without notice.
II	Preliminary data	Qualification	This data sheet contains data from the preliminary specification. Supplementary data will be published at a later date. Philips Semiconductors reserves the right to change the specification without notice, in order to improve the design and supply the best possible product.
III	Product data	Production	This data sheet contains data from the product specification. Philips Semiconductors reserves the right to make changes at any time in order to improve the design, manufacturing and supply. Relevant changes will be communicated via a Customer Product/Process Change Notification (CPCN).

Notes

1. Please consult the most recently issued data sheet before initiating or completing a design.
2. The product status of the device(s) described in this data sheet may have changed since this data sheet was published. The latest information is available on the Internet at URL <http://www.semiconductors.philips.com>.
3. For data sheets describing multiple type numbers, the highest-level product status determines the data sheet status.

DEFINITIONS

Short-form specification — The data in a short-form specification is extracted from a full data sheet with the same type number and title. For detailed information see the relevant data sheet or data handbook.

Limiting values definition — Limiting values given are in accordance with the Absolute Maximum Rating System (IEC 60134). Stress above one or more of the limiting values may cause permanent damage to the device. These are stress ratings only and operation of the device at these or at any other conditions above those given in the Characteristics sections of the specification is not implied. Exposure to limiting values for extended periods may affect device reliability.

Application information — Applications that are described herein for any of these products are for illustrative purposes only. Philips Semiconductors make no representation or warranty that such applications will be suitable for the specified use without further testing or modification.

DISCLAIMERS

Life support applications — These products are not designed for use in life support appliances, devices, or systems where malfunction of these products can reasonably be expected to result in personal injury. Philips Semiconductors customers using or selling these products for use in such applications do so at their own risk and agree to fully indemnify Philips Semiconductors for any damages resulting from such application.

Right to make changes — Philips Semiconductors reserves the right to make changes in the products - including circuits, standard cells, and/or software - described or contained herein in order to improve design and/or performance. When the product is in full production (status 'Production'), relevant changes will be communicated via a Customer Product/Process Change Notification (CPCN). Philips Semiconductors assumes no responsibility or liability for the use of any of these products, conveys no licence or title under any patent, copyright, or mask work right to these products, and makes no representations or warranties that these products are free from patent, copyright, or mask work right infringement, unless otherwise specified.

Quad bilateral switches

74HC4066; 74HCT4066

NOTES

Quad bilateral switches

74HC4066; 74HCT4066

NOTES

Quad bilateral switches

74HC4066; 74HCT4066

NOTES

Philips Semiconductors – a worldwide company

Contact information

For additional information please visit <http://www.semiconductors.philips.com>. Fax: +31 40 27 24825

For sales offices addresses send e-mail to: sales.addresses@www.semiconductors.philips.com.

© Koninklijke Philips Electronics N.V. 2003

SCA75

All rights are reserved. Reproduction in whole or in part is prohibited without the prior written consent of the copyright owner.

The information presented in this document does not form part of any quotation or contract, is believed to be accurate and reliable and may be changed without notice. No liability will be accepted by the publisher for any consequence of its use. Publication thereof does not convey nor imply any license under patent- or other industrial or intellectual property rights.

Printed in The Netherlands

613508/04/pp32

Date of release: 2003 Jun 17

Document order number: 9397 750 11264

Let's make things better.

**Philips
Semiconductors**



PHILIPS