

NPN Silicon RF Transistor

- For highest gain low noise amplifier at 1.8 GHz and 2 mA / 2 V
Outstanding $G_{ms} = 23$ dB
Noise Figure $F = 0.95$ dB
- For oscillators up to 15 GHz
- Transition frequency $f_T = 45$ GHz
- Gold metallization for high reliability
- **SIEGET® 45 - Line**
45 GHz f_T - Line

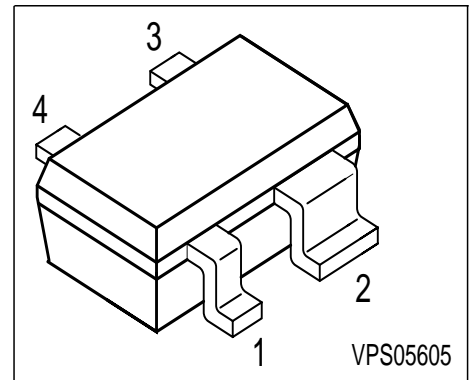

ESD: Electrostatic discharge sensitive device, observe handling precaution!

Type	Marking	Pin Configuration				Package
BFP520	APs	1 = B	2 = E	3 = C	4 = E	SOT343

Maximum Ratings

Parameter	Symbol	Value	Unit
Collector-emitter voltage	V_{CEO}	2.5	V
Collector-base voltage	V_{CBO}	10	
Emitter-base voltage	V_{EBO}	1	
Collector current	I_C	40	mA
Base current	I_B	4	
Total power dissipation $T_S \leq 105$ °C ¹⁾	P_{tot}	100	mW
Junction temperature	T_j	150	°C
Ambient temperature	T_A	-65 ... 150	
Storage temperature	T_{stg}	-65 ... 150	

Thermal Resistance

Junction - soldering point ²⁾	R_{thJS}	≤ 450	K/W
--	------------	------------	-----

¹⁾ T_S is measured on the collector lead at the soldering point to the pcb

²⁾ For calculation of R_{thJA} please refer to Application Note Thermal Resistance

Electrical Characteristics at $T_A = 25^\circ\text{C}$, unless otherwise specified.

Parameter	Symbol	Values			Unit
		min.	typ.	max.	
DC characteristics					
Collector-emitter breakdown voltage $I_C = 1 \text{ mA}, I_B = 0$	$V_{(BR)CEO}$	2.5	3	3.5	V
Collector-base cutoff current $V_{CB} = 5 \text{ V}, I_E = 0$	I_{CBO}	-	-	200	nA
Emitter-base cutoff current $V_{EB} = 1 \text{ V}, I_C = 0$	I_{EBO}	-	-	35	μA
DC current gain $I_C = 20 \text{ mA}, V_{CE} = 2 \text{ V}$	h_{FE}	70	110	200	-
AC characteristics (verified by random sampling)					
Transition frequency $I_C = 30 \text{ mA}, V_{CE} = 2 \text{ V}, f = 2 \text{ GHz}$	f_T	-	45	-	GHz
Collector-base capacitance $V_{CB} = 2 \text{ V}, f = 1 \text{ MHz}$	C_{cb}	-	0.06	-	pF
Collector-emitter capacitance $V_{CE} = 2 \text{ V}, f = 1 \text{ MHz}$	C_{ce}	-	0.3	-	
Emitter-base capacitance $V_{EB} = 0.5 \text{ V}, f = 1 \text{ MHz}$	C_{eb}	-	0.35	-	
Noise figure $I_C = 2 \text{ mA}, V_{CE} = 2 \text{ V}, Z_S = Z_{Sopt}, f = 1.8 \text{ GHz}$	F	-	0.95	-	dB
Power gain, maximum stable ¹⁾ $I_C = 20 \text{ mA}, V_{CE} = 2 \text{ V}, Z_S = Z_{Sopt}, Z_L = Z_{Lopt}, f = 1.8 \text{ GHz}$	G_{ms}	-	23	-	
Insertion power gain $I_C = 20 \text{ mA}, V_{CE} = 2 \text{ V}, f = 1.8 \text{ GHz}, Z_S = Z_L = 50\Omega$	$ S_{21} ^2$	-	21	-	dBm
Third order intercept point at output $V_{CE} = 2 \text{ V}, f = 1.8 \text{ GHz}, Z_S = Z_{Sopt}, Z_L = Z_{Lopt}, I_C = 20 \text{ mA}$ $I_C = 7 \text{ mA}$	IP_3	-	25	-	
1dB compression point $V_{CE} = 2 \text{ V}, f = 1.8 \text{ GHz}, Z_S = Z_{Sopt}, Z_L = Z_{Lopt}, I_C = 20 \text{ mA}$ $I_C = 7 \text{ mA}$	P_{-1dB}	-	12	-	
		-	5	-	

$$^1G_{ms} = |S_{21} / S_{12}|$$

Common Emitter S-Parameters

f	S ₁₁		S ₂₁		S ₁₂		S ₂₂	
	MAG	ANG	MAG	ANG	MAG	ANG	MAG	ANG
V _{CE} = 2 V, I _C = 20 mA								
0.01	0.7244	-0.7	32.273	178.6	0.0007	69.4	0.9052	1.2
0.1	0.7251	-8.4	31.637	171.4	0.0041	92.8	0.9363	-4.4
0.5	0.6368	-40.7	27.293	140.7	0.0194	75.9	0.8523	-26.7
1	0.4768	-73.6	19.601	113.5	0.0351	66.5	0.6496	-46.1
2	0.2816	-123.8	11.021	84.9	0.0057	56.3	0.3818	-64.6
3	0.2251	-166.1	7.481	67.6	0.0788	49.2	0.2407	-73.6
4	0.2552	156.2	5.636	53.1	0.0994	41.5	0.1544	-95.3
5	0.3207	133.6	4.488	39.7	0.1177	32.9	0.0951	-128.9
6	0.3675	118.7	3.683	27.5	0.1343	24.7	0.0545	177.6

Common Emitter Noise Parameters

f	F _{min} 1)	G _a 1)	Γ _{opt}		R _N	r _n	F _{50Ω} 2)	S ₂₁ ² 2)
	dB	dB	MAG	ANG	Ω	-	dB	dB
V _{CE} = 2 V, I _C = 2 mA								
0.9	0.72	21.5	0.64	14	21.5	0.43	1.75	16.11
1.8	0.95	20.1	0.49	30	19.1	0.38	1.55	15.14
2.4	1.07	16.1	0.45	41	18.1	0.36	1.61	14.07
3	1.31	14.5	0.41	54	16.5	0.33	1.71	13.13
4	1.35	11.6	0.26	82	12.5	0.25	1.61	11.49
5	1.71	9.5	0.14	128	9.1	0.18	1.85	9.87
6	1.95	8.1	0.12	151	8.1	0.16	1.95	8.28

V_{CE} = 2 V, I_C = 5 mA

0.9	0.89	22.1	0.49	12	16.1	0.32	1.51	21.94
1.8	1.08	20.5	0.38	22	14.1	0.28	1.38	19.34
2.4	1.12	18.1	0.34	33	14.1	0.28	1.41	17.54
3	1.32	16.2	0.29	45	13.5	0.27	1.51	16.01
4	1.35	13.5	0.16	71	11.1	0.22	1.45	13.82
5	1.61	11.5	0.08	120	10.1	0.21	1.65	11.93
6	1.81	10.5	0.07	150	8.1	0.16	1.81	10.23

1) Input matched for minimum noise figure, output for maximum gain

2) Z_S = Z_L = 50Ω

For more and detailed S- and Noise-parameters please contact your local Infineon Technologies distributor or sales office to obtain a Infineon Technologies Application Notes CD-ROM or see Internet: <http://www.infineon.com/silicondiscretes>

SPICE Parameters (Gummel-Poon Model, Berkley-SPICE 2G.6 Syntax) :
Transistor Chip Data

IS =	15	aA	BF =	235	-	NF =	1	-
VAF =	25	V	IKF =	0.4	A	ISE =	25	fA
NE =	2	-	BR =	1.5	-	NR =	1	-
VAR =	2	V	IKR =	0.01	A	ISC =	20	fA
NC =	2	-	RB =	11	Ω	IRB =	-	A
RBM =	7.5	Ω	RE =	0.6		RC =	7.6	Ω
CJE =	235	fF	VJE =	0.958	V	MJE =	0.335	-
TF =	1.7	ps	XTF =	10	-	VTF =	5	V
ITF =	0.7	A	PTF =	50	deg	CJC =	93	fF
VJC =	0.661	V	MJC =	0.236	-	XCJC =	1	-
TR =	50	ns	CJS =	0	fF	VJS =	0.75	V
MJS =	0.333	-	XTB =	-0.25	-	EG =	1.11	eV
XTI =	0.035	-	FC =	0.5	-	TNOM	298	K

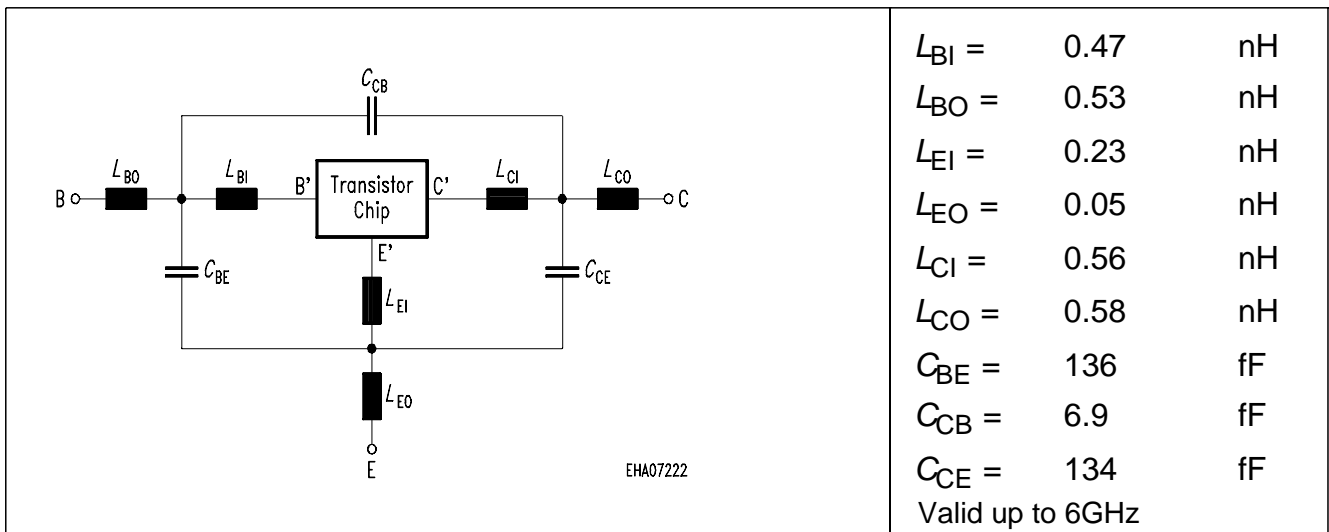
Package Equivalent Circuit:

The SOT-343 package has two emitter leads. To avoid high complexity of the package equivalent circuit, both leads are combined in one electrical connection.

For examples and ready to use parameters please contact your local Infineon Technologies distributor or sales office to obtain a Infineon Technologies CD-ROM or see Internet:
<http://www.infineon.com/silicondiscretes>

For non-linear simulation:

- Use transistor chip parameters in Berkeley SPICE 2G.6 syntax for all simulators.
- Simulation of the package is not necessary for frequencies < 100MHz.
For higher frequencies please add the wiring of the package equivalent circuit around the non-linear transistor.

Advantages of the common emitter configuration:

- Higher gain because of lower emitter inductance.
- Power is dissipated via the grounded emitter leads, because the chip is mounted on the copper emitter leadframe.

Please note, that the broadest lead is the emitter lead.

Total power dissipation $P_{tot} = f(T_S)$

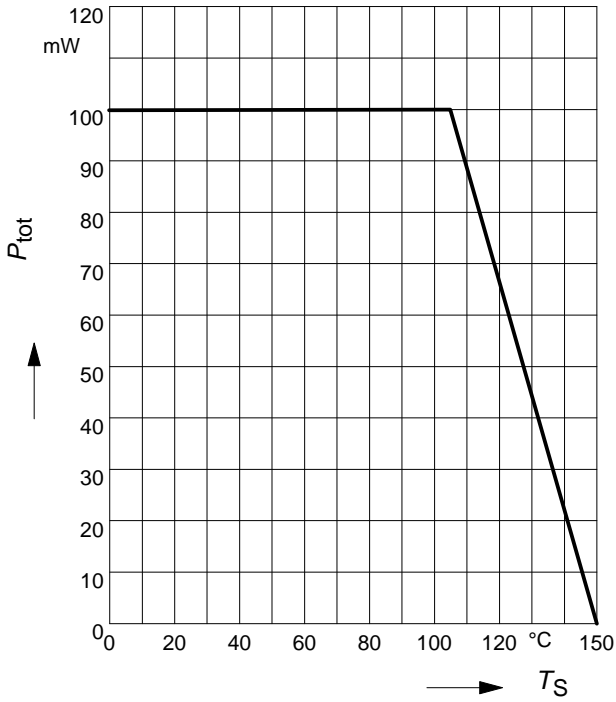

Transition frequency $f_T = f(I_C)$

$f = 2$ GHz

$V_{CE} =$ parameter in V

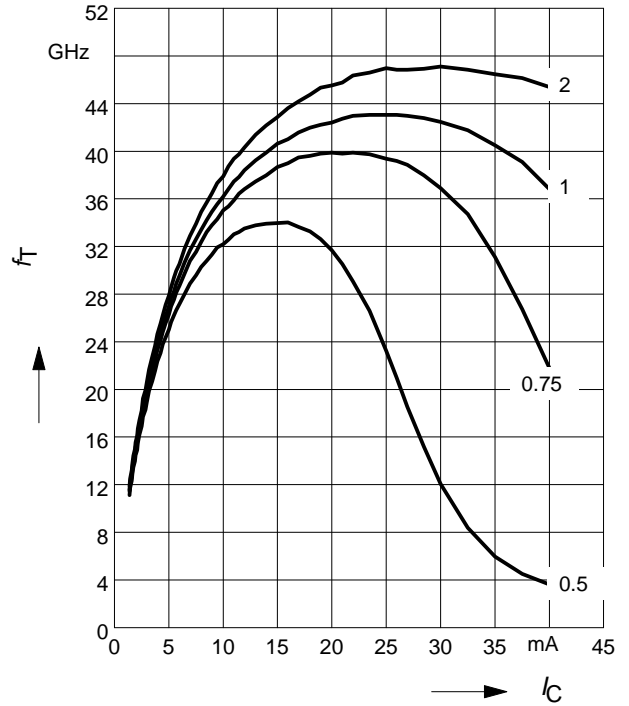

Permissible Pulse Load $R_{thJS} = f(t_p)$

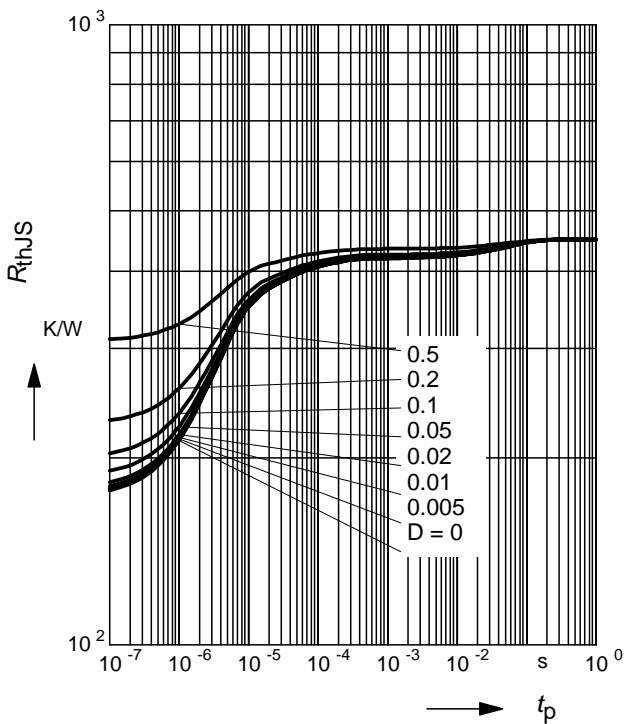

Permissible Pulse Load

$P_{totmax}/P_{totDC} = f(t_p)$

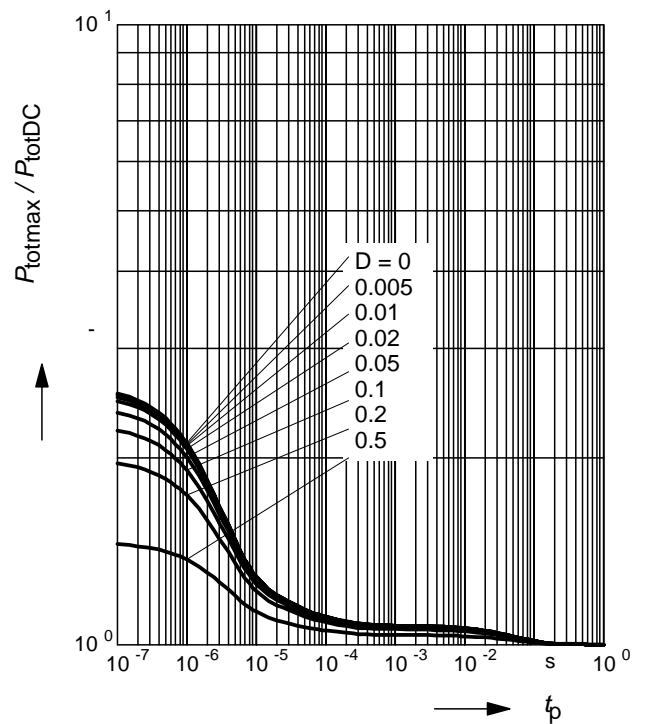

Power gain G_{ma} , G_{ms} , $|S_{21}|^2 = f(f)$

$V_{CE} = 2V$, $I_C = 20\text{ mA}$

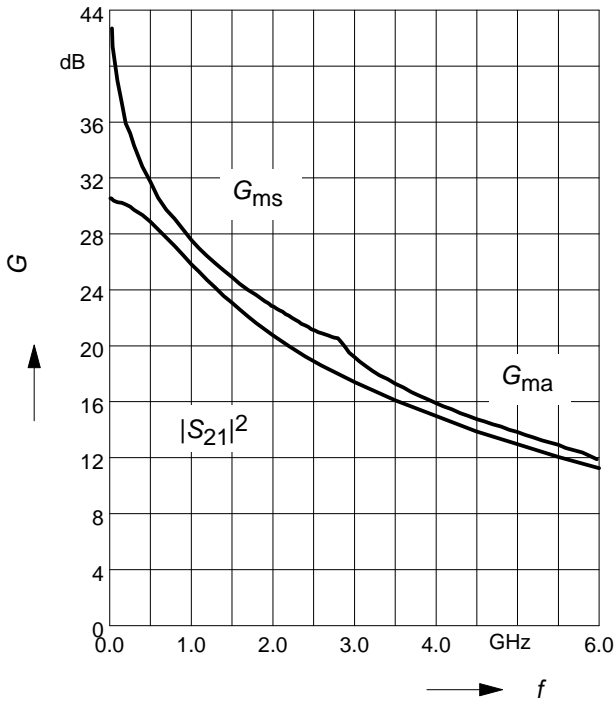

Power gain G_{ma} , $G_{ms} = f(I_C)$

$V_{CE} = 2V$

$f = \text{parameter in GHz}$

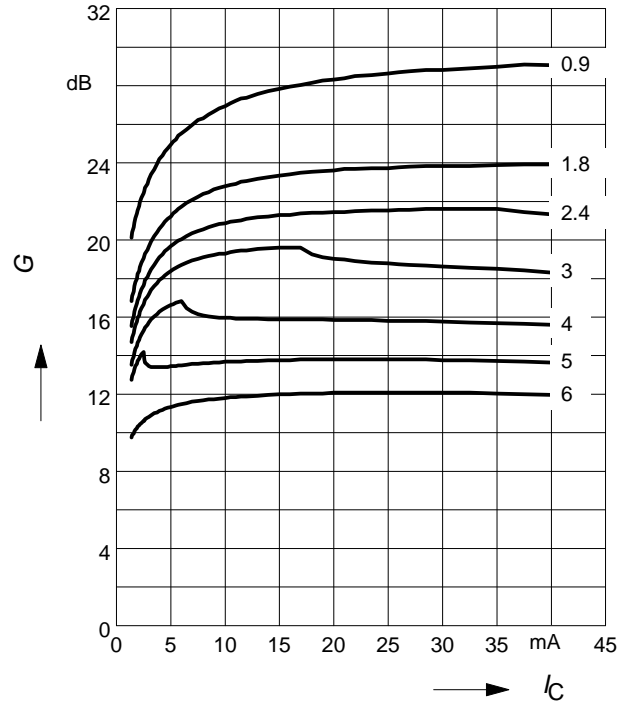

Power gain G_{ma} , $G_{ms} = f(V_{CE})$

$I_C = 20\text{ mA}$

$f = \text{parameter in GHz}$

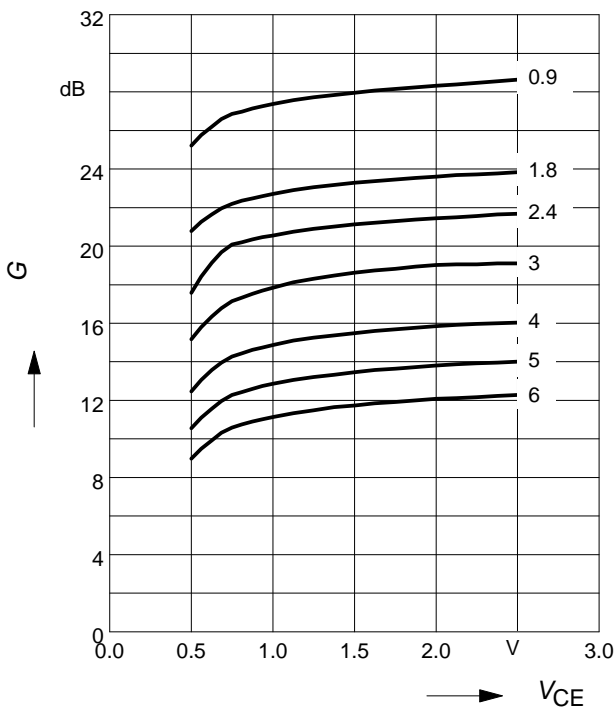

Collector-base capacitance $C_{cb} = f(V_{CB})$

$f = 1\text{ MHz}$

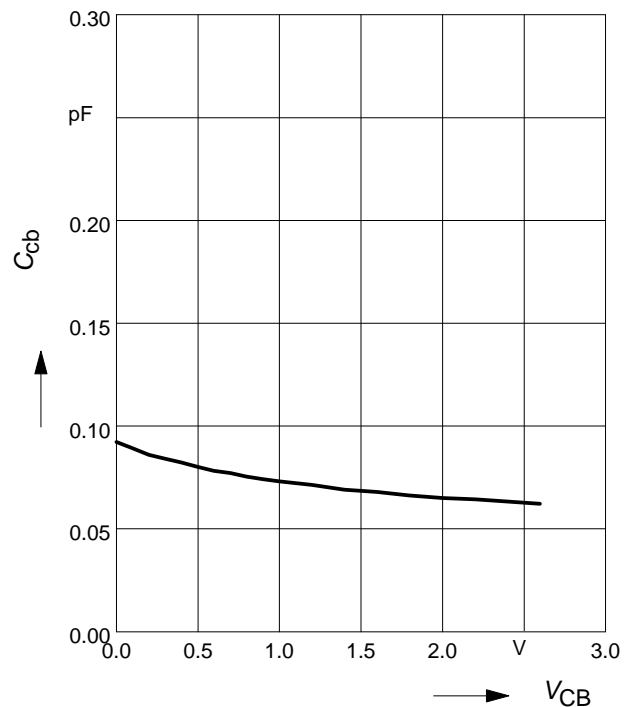

Noise figure $F = f(I_C)$

$V_{CE} = 2\text{ V}$, $Z_S = Z_{Sopt}$

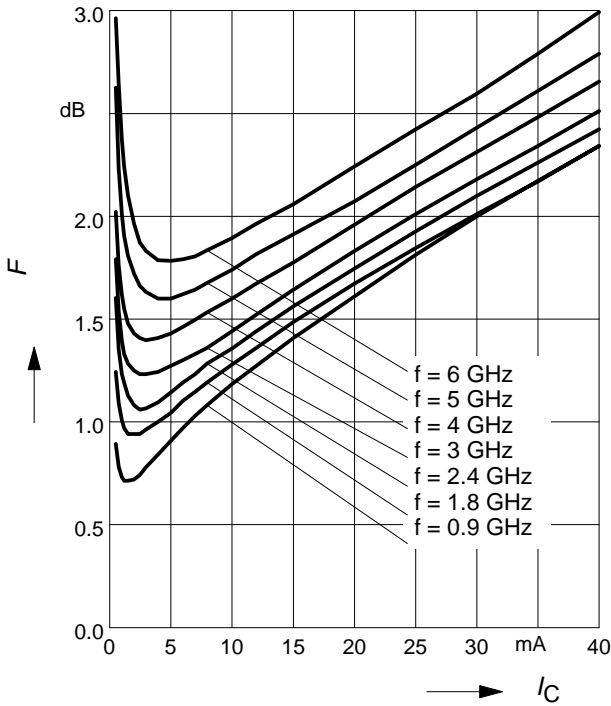

Noise figure $F = f(I_C)$

$V_{CE} = 2\text{ V}$, $f = 1.8\text{ GHz}$

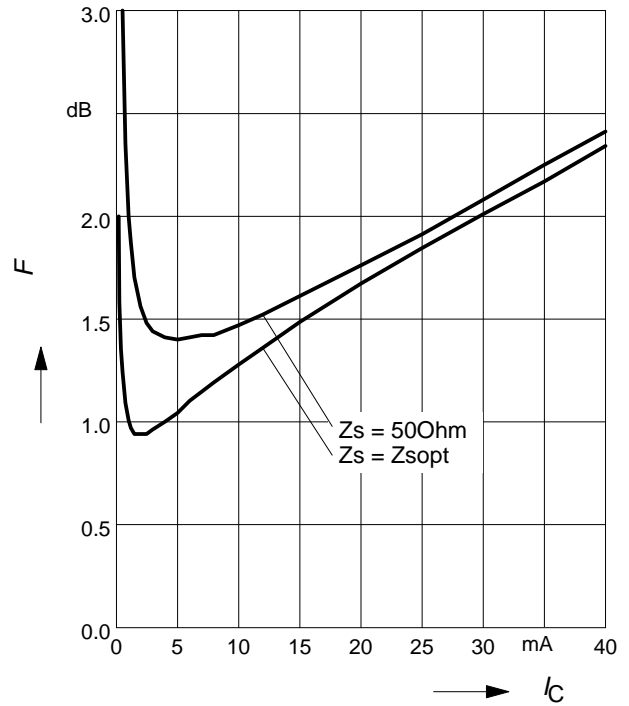

Noise figure $F = f(f)$

$V_{CE} = 2\text{ V}$, $Z_S = Z_{Sopt}$

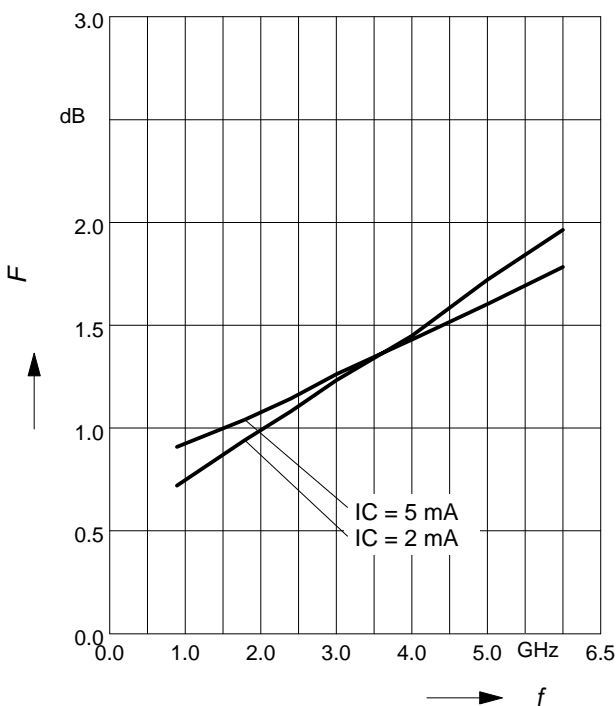

Source impedance for min. noise figure vs. Frequency

$V_{CE} = 2\text{ V}$, $I_C = 2\text{ mA} / 5\text{ mA}$

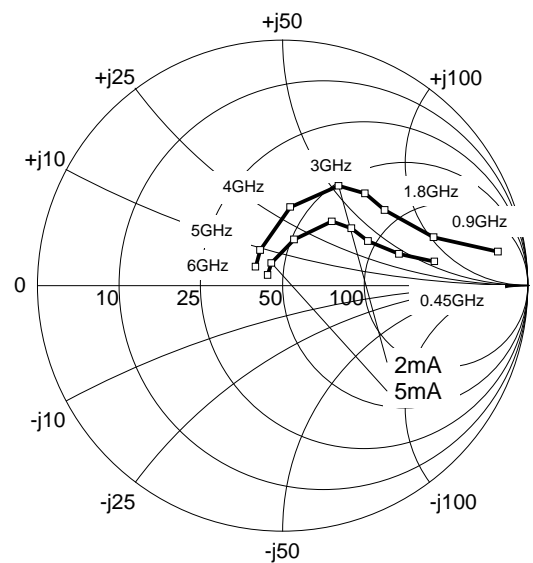

This datasheet has been download from:

www.datasheetcatalog.com

Datasheets for electronics components.